

# Heritage and challenges for next generation charged cosmic-ray space missions

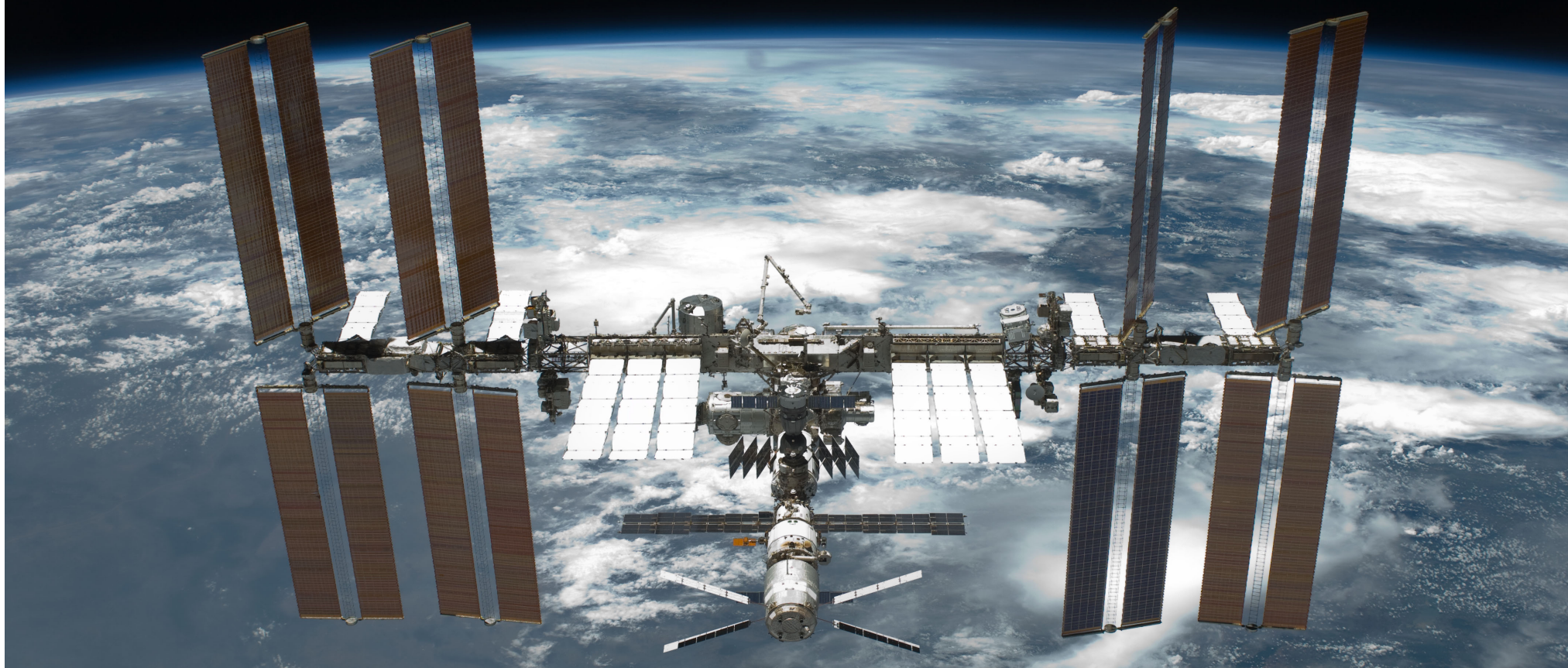

# Cosmic Rays

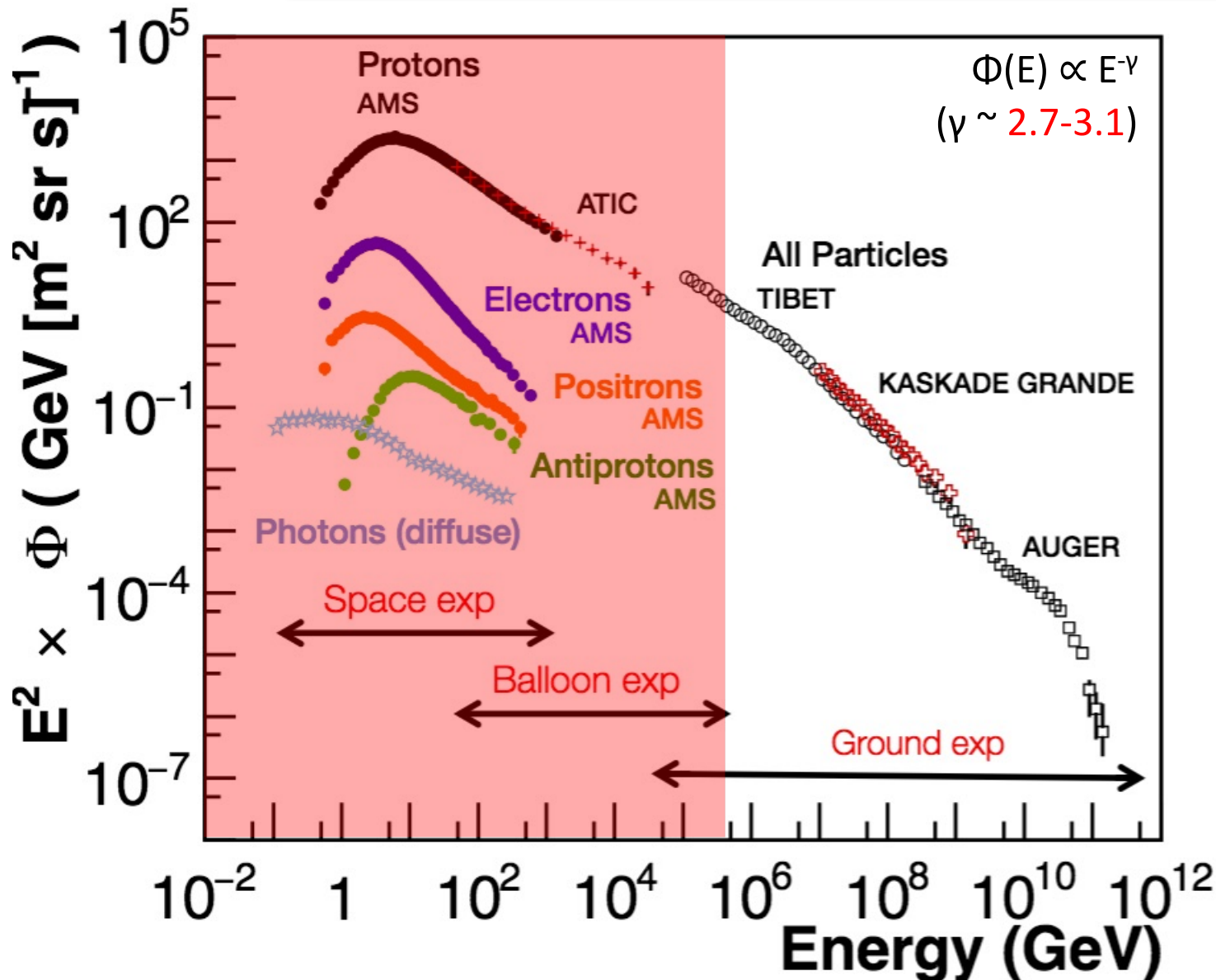

measuring in Space (or balloon) allows to measure at single particle level  
 → precise composition and spectra measurement

BUT

cosmic ray spectra are typically power laws:  
 1 order of magnitude in energy  
 → 3 orders of magnitude in flux  
 → 2 orders of magnitude in collected counts (i.e. in statistics)

CALET coll., O. Adriani et al., Phys. Rev. Lett. 128, 131103 (2022)

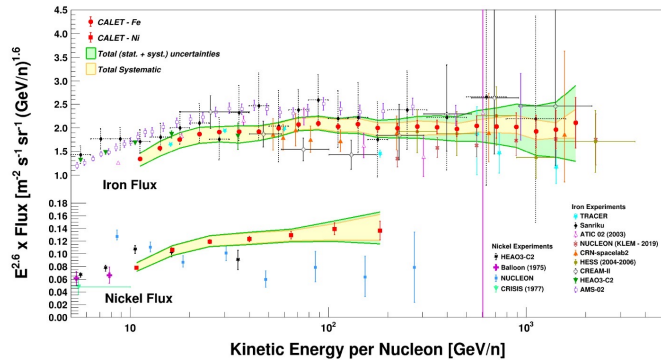

DAMPE coll., F. Alemanno et al., PoS (ICRC2023) 138

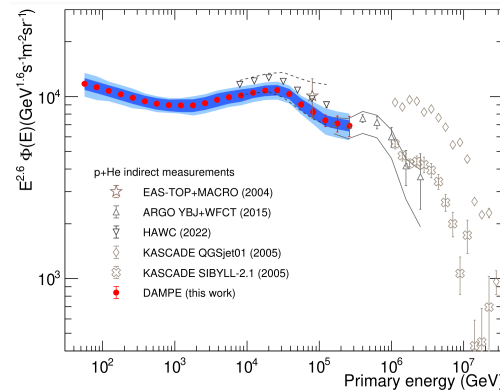

AMS coll., M. Aguilar et al., Phys. Rev. Lett. 122, 041102 (2019)

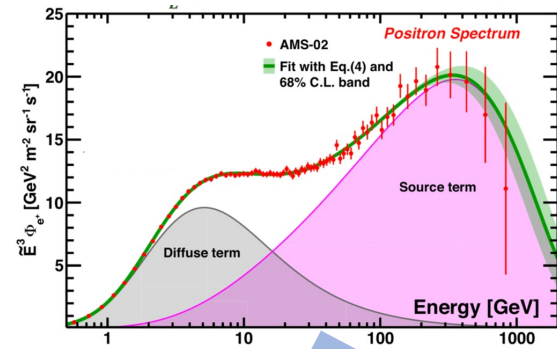

- I. What is the origin of the **hardening** observed in the spectra of CR nuclei at rigidity of 300 GV and ~10 TV?
- II. Why is the slope of the spectrum of CR **proton and helium** different?
- III. What is the origin of the prominent **break** observed at a particle energy of **1 TeV in the electron spectrum**?
- IV. Why do the **proton, positron, and antiproton** spectra have roughly same slopes at particle energies larger than 10 GeV?
- V. What is the origin of the **rise in the positron fraction** at particle energies above 10 GeV?

S. Gabici @ ICRC 2023  
CR direct rapporteur

**COMPOSITION**  
frontier

**ENERGY**  
frontier

**ANTIMATTER**  
frontier

In general the goal is:

- measurement of CR nuclear composition in the 100 TeV - PeV energies for a comprehensive assessment of CR origin, acceleration and transport mechanisms
- Measure CR electron anisotropies and flux beyond 10 TeV (search for nearby astrophysical electron sources)
- Extend measurements of isotopic composition of CRs above 10 GeV/n (determination of halo size, high energy interactions, ...)
- Ultra-heavy trans-Iron CR composition (association of neutron-rich CR sources, ..)
- Search for new physics signatures in CR measurements:
  - New physics signatures in low-energy nuclear antimatter fluxes (e.g., anti-D, anti-He)
  - New physics signatures in high-energy antiprotons and positron/electron fluxes
  - Measurement of secondary positrons above the TeV break
  - Search for exotica or Beyond-Standard-Model physics

# The experimental challenge

No atmosphere:

- Stratospheric balloon
- Satellite / Space stations / Moon (?)



Limits on **size / weight / time / power consumption**

With a detector design focused on specific measurements, is "easy" to optimize and cope with the limitations



Antimatter / Isotopes  
Nuclei /  $e^+e^-$  /  $\gamma$



Magnetic spectrometers  
Calorimeters

When going for a general purpose detector, this is much more complicated...

Current experiments – key concepts/detectors  
(AMS, mainly, and DAMPE used as examples)

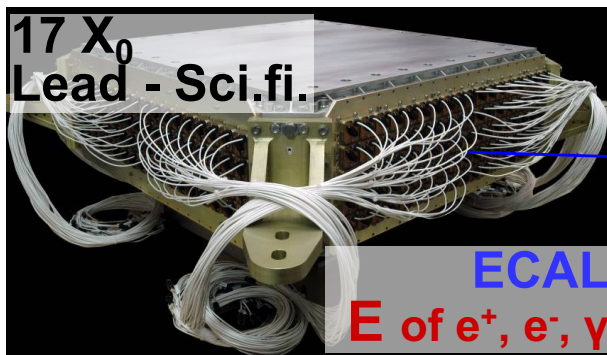
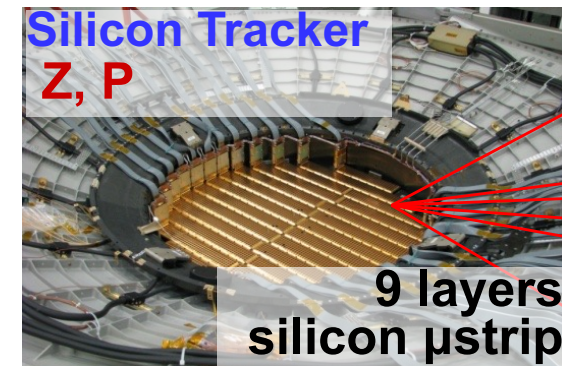

$Z, P$  independently measured by  
Tracker, RICH, TOF and ECAL

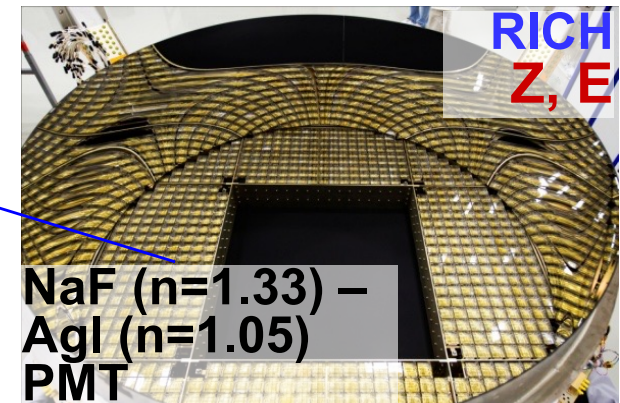
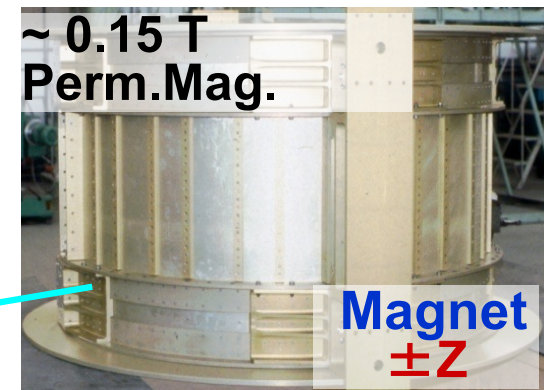
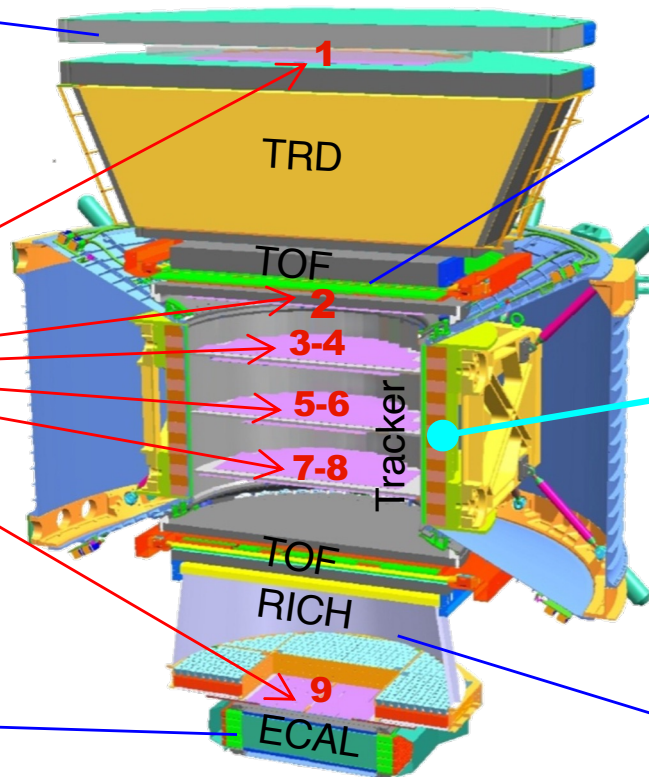

On ISS since 16 May 2011

In orbit since 17 December 2015

**PSD:** double layer of scintillating strip detector acting as ACD (anti-counter) + charge measurement

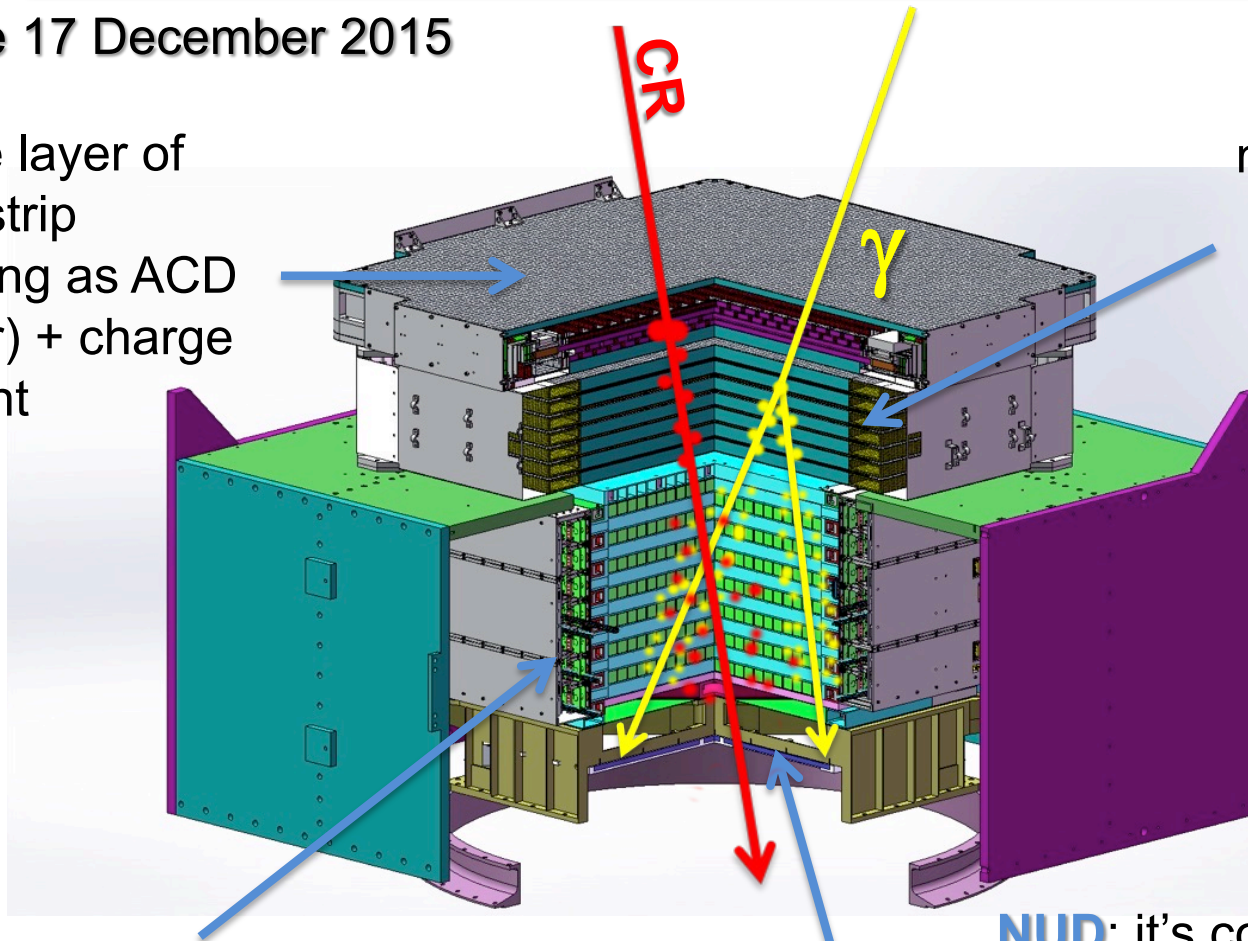

**STK:** 6 tracking double layer + 3 mm tungsten plates. Used for particle track, charge measurement and photon conversion ( $\sim 2 X_0$ )

**BGO:** the calorimeter is made of 308 BGO bars in hodoscopic arrangement ( $\sim 31 X_0$ ). Performs energy measurements, hadron/lepton identification (*e/p rejection*), and trigger

**NUD:** it's complementary to the BGO e/p rejection, by measuring the thermal neutron shower activity. Made up of boron-doped plastic scintillator

# How to identify&measure

---

- measure energy/momentum:
  - calorimetry
  - magnetic spectrometry
  - time of flight
  - Cherenkov
  - transition radiation
- measure sign of charge:
  - magnetic spectrometry + time of flight
  - topology of annihilation (tracking/calorimetry)
- measure charge:
  - $dE/dx$  (tracking/scintillation)
  - number of photons in Cherenkov radiation
- measure mass ( $\beta/\gamma + E/p$ ):
  - time of flight
  - Cherenkov
  - transition radiation
- hadron/lepton separation:
  - transition radiation
  - shower development topology (imaging calorimetry)
  - energy/momentum match
  - neutron produced in hadronic shower (neutron detector)
  - calorimeter back-scattering timing measurement ?



# Key concepts/detectors

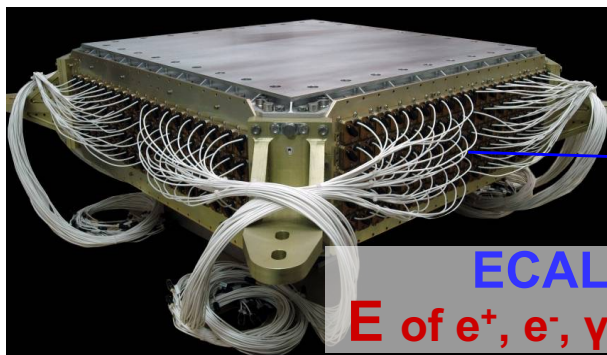
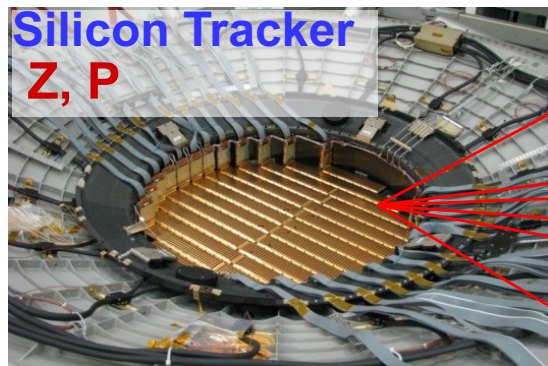

## Techniques:

- Transition Radiation
- Shower development topology

- Energy/Momentum (E/p) match
- neutrons produced in the hadronic shower

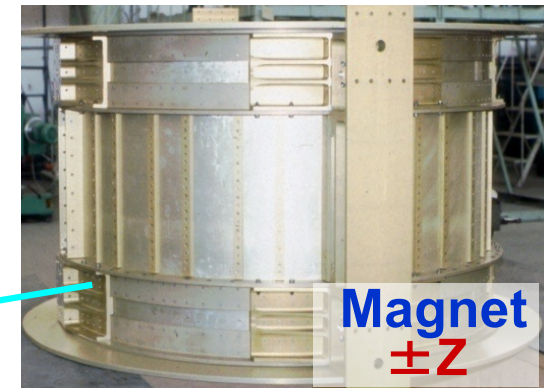
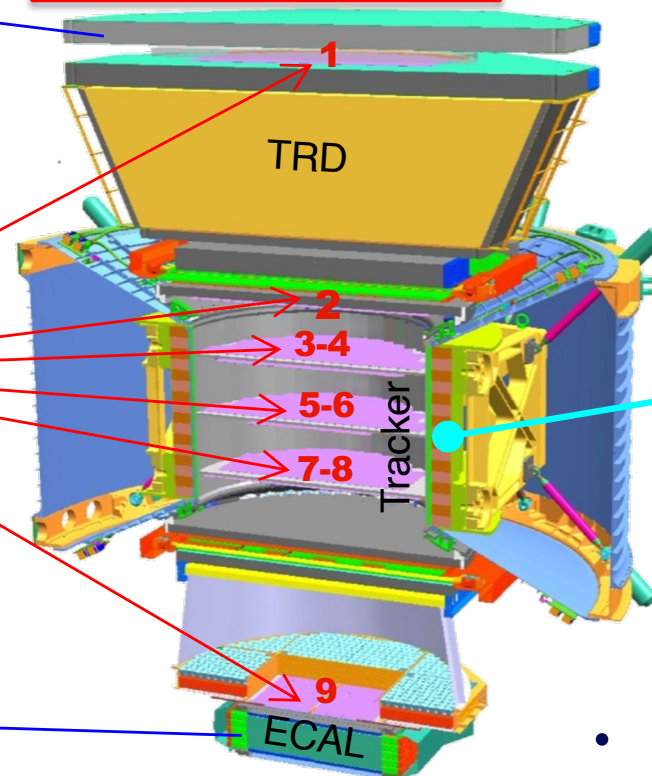

## Electron/proton separation:

- $e^-$  wrt the p background
- $e^+$  wrt to the p background
- anti-p wrt to the  $e^-$  background
- $\gamma$ 's wrt the p background

# Shower development topology: segmentation (longitudinal and lateral)

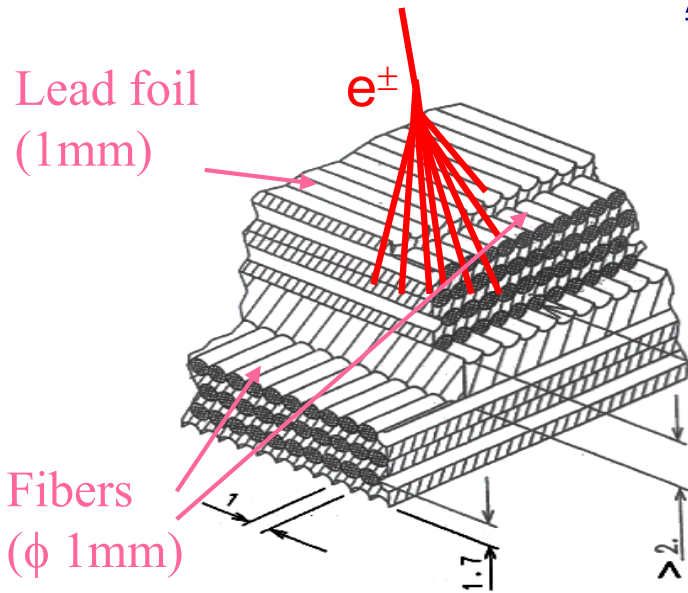

## AMS ECAL:

- Lead-SciFi sampling calorimeter
- 18 layers (9 super-layers)
- 17  $X_0$

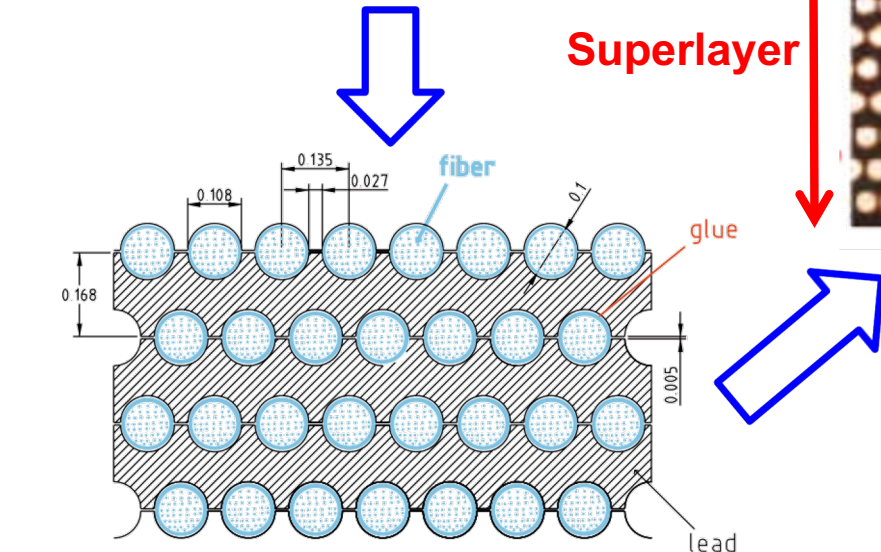
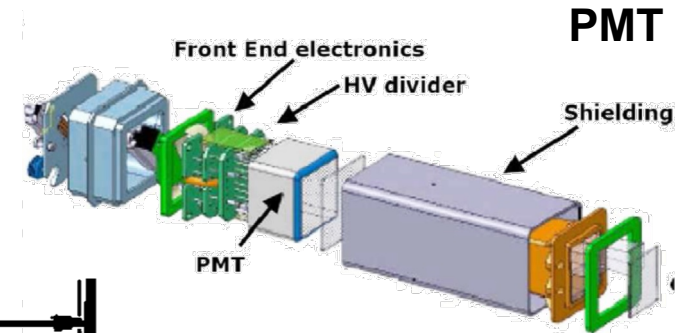

## Superlayer

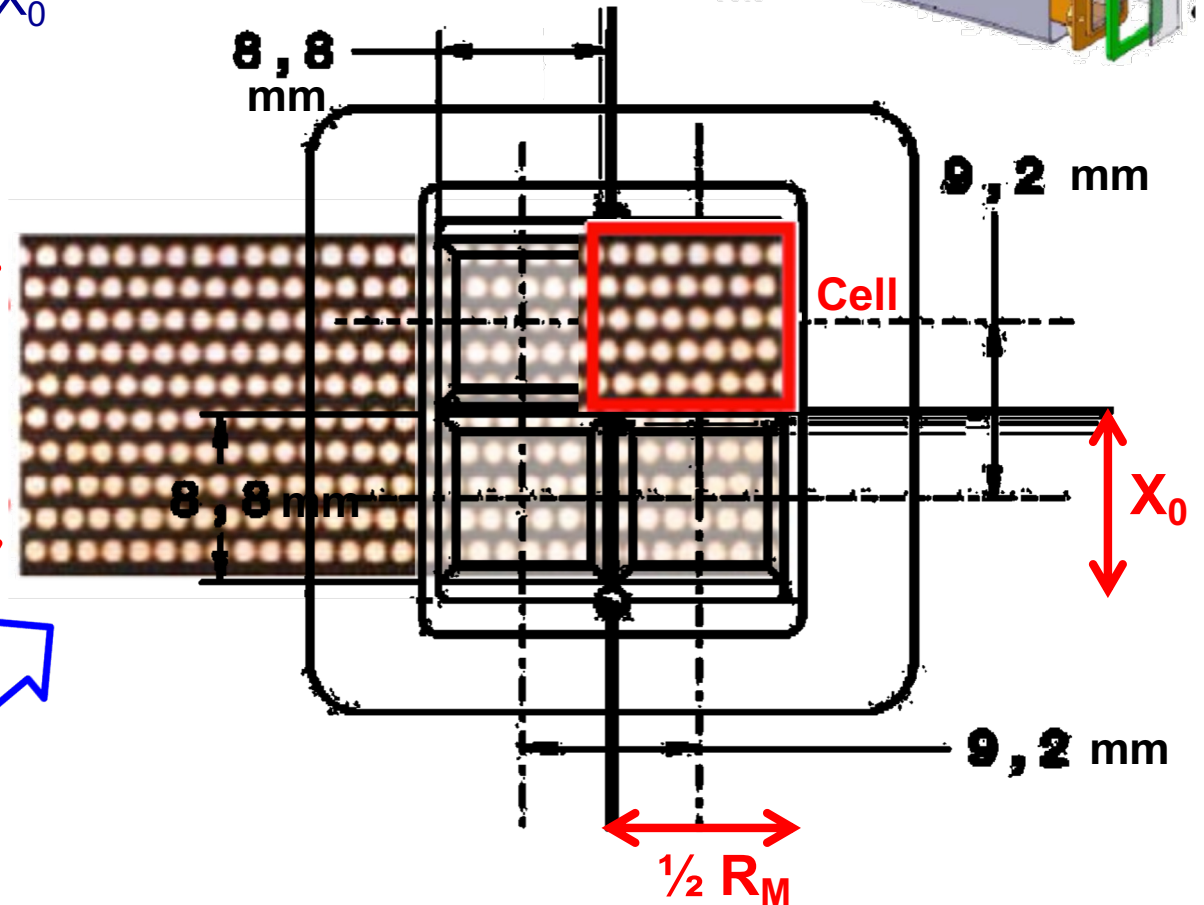

# Shower development topology: segmentation (longitudinal and lateral)

## DAMPE BGO:

- homogeneous calorimeter
- $\sim 31 X_0$
- 14 layers  
( $\sim 2X_0$  per layer)

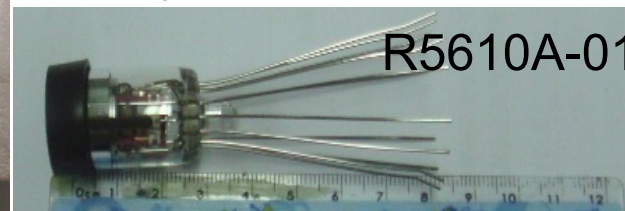
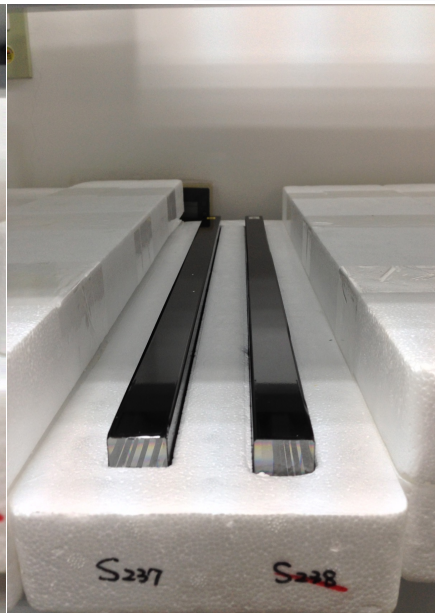
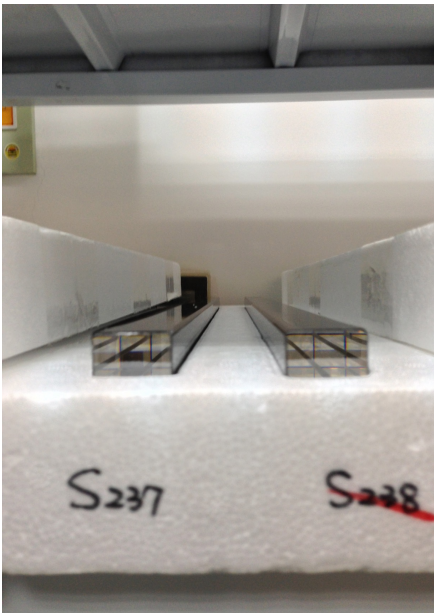
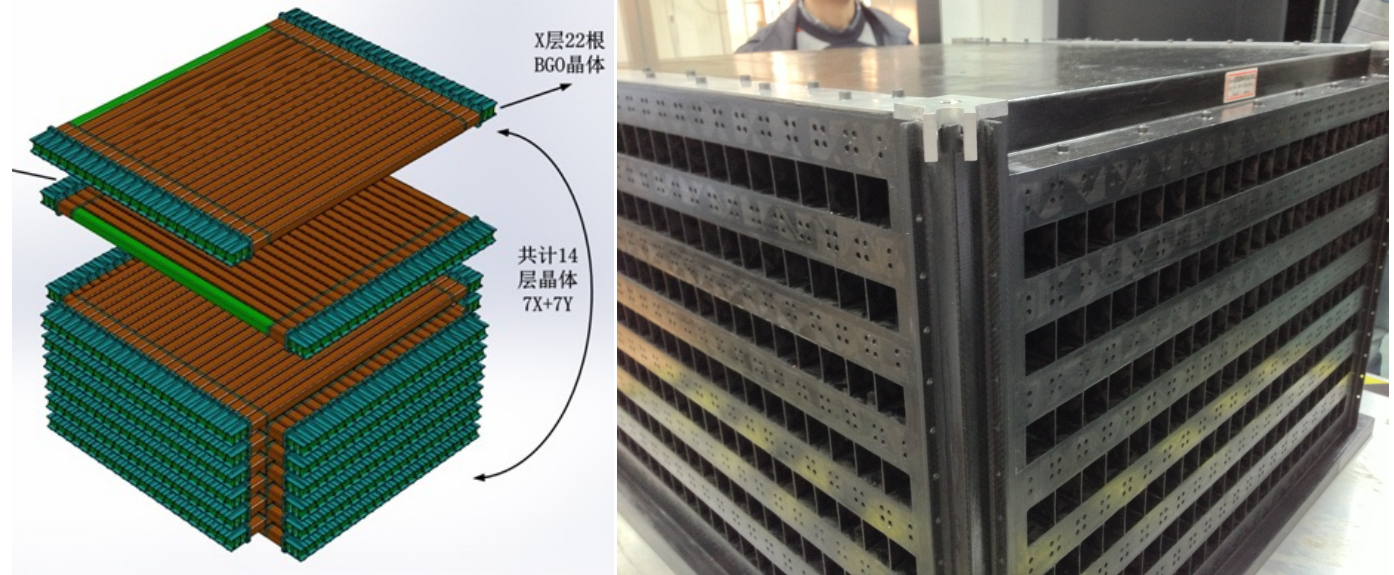

308 bars  
616 PMTs

# Key concepts/detectors



## Techniques:

- $dE/dx$
- number of photons in the Cherenkov radiation

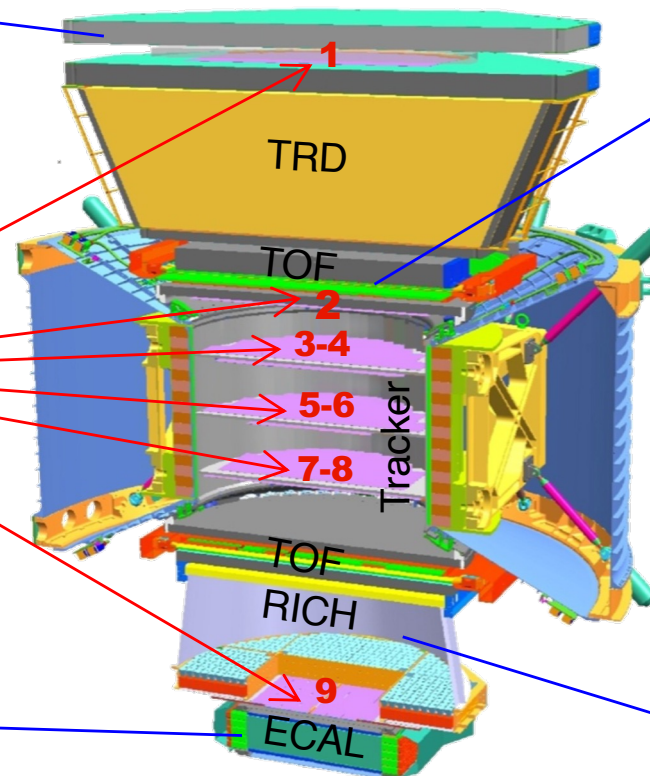
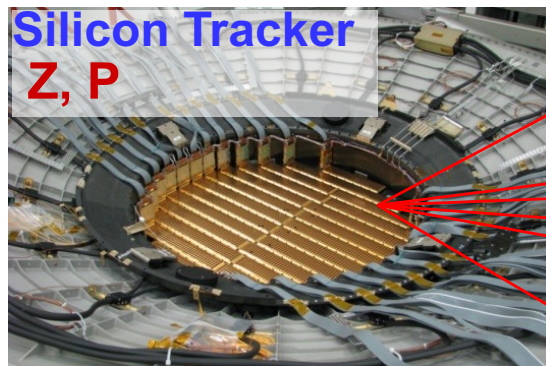

## Charge measurement:

- identify the different nuclear species
  - control the fragmentations (if multiple measurements along the detector)

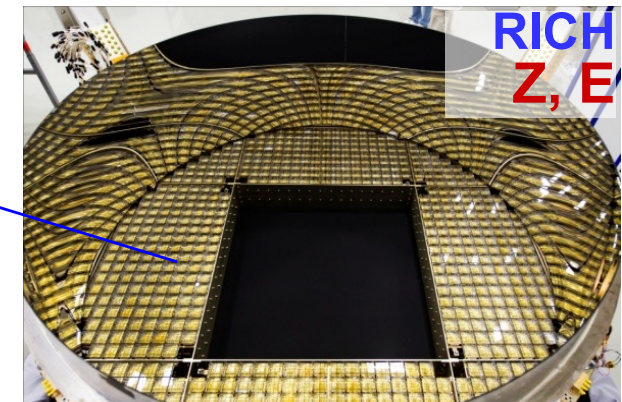
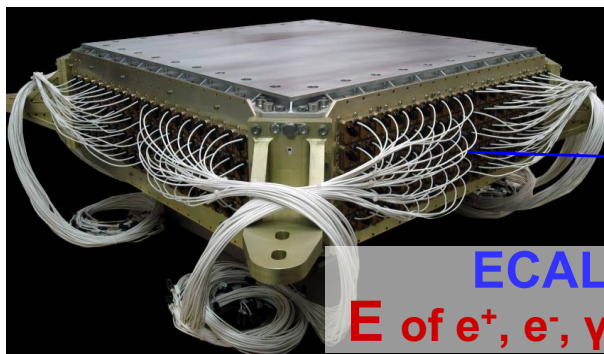

# Key concepts/detectors

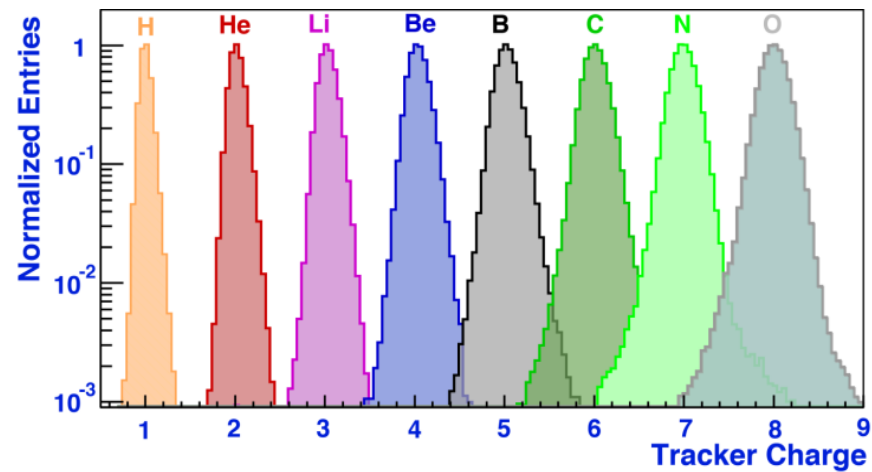
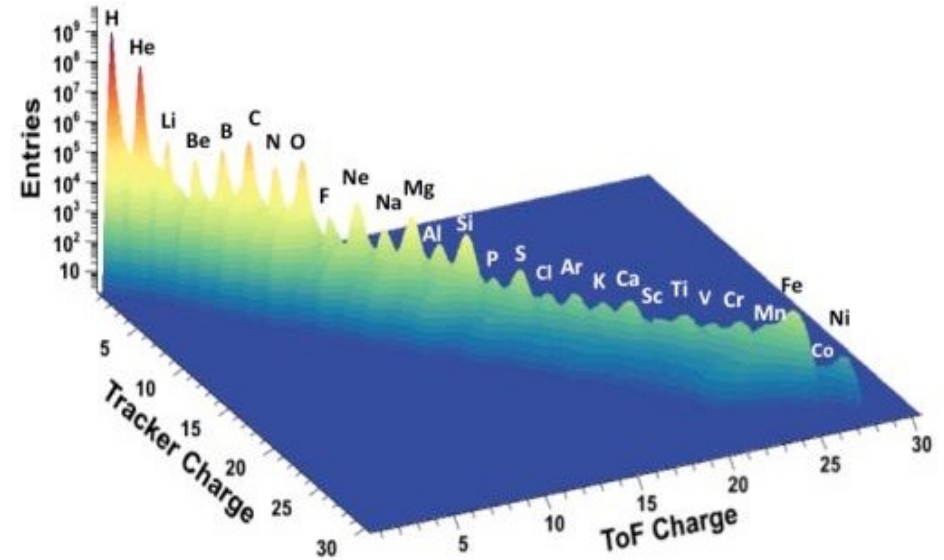
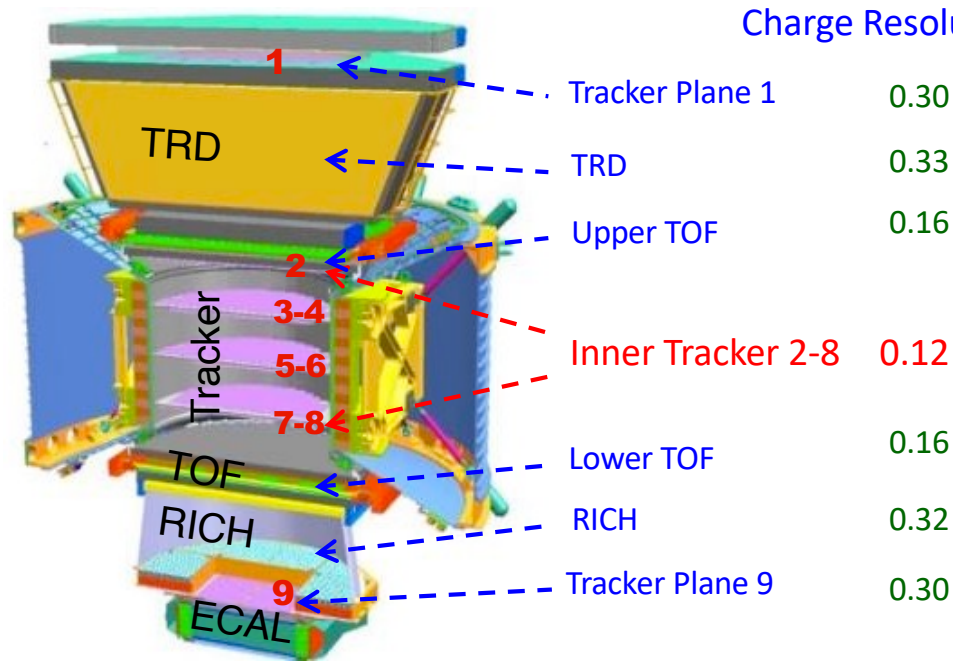

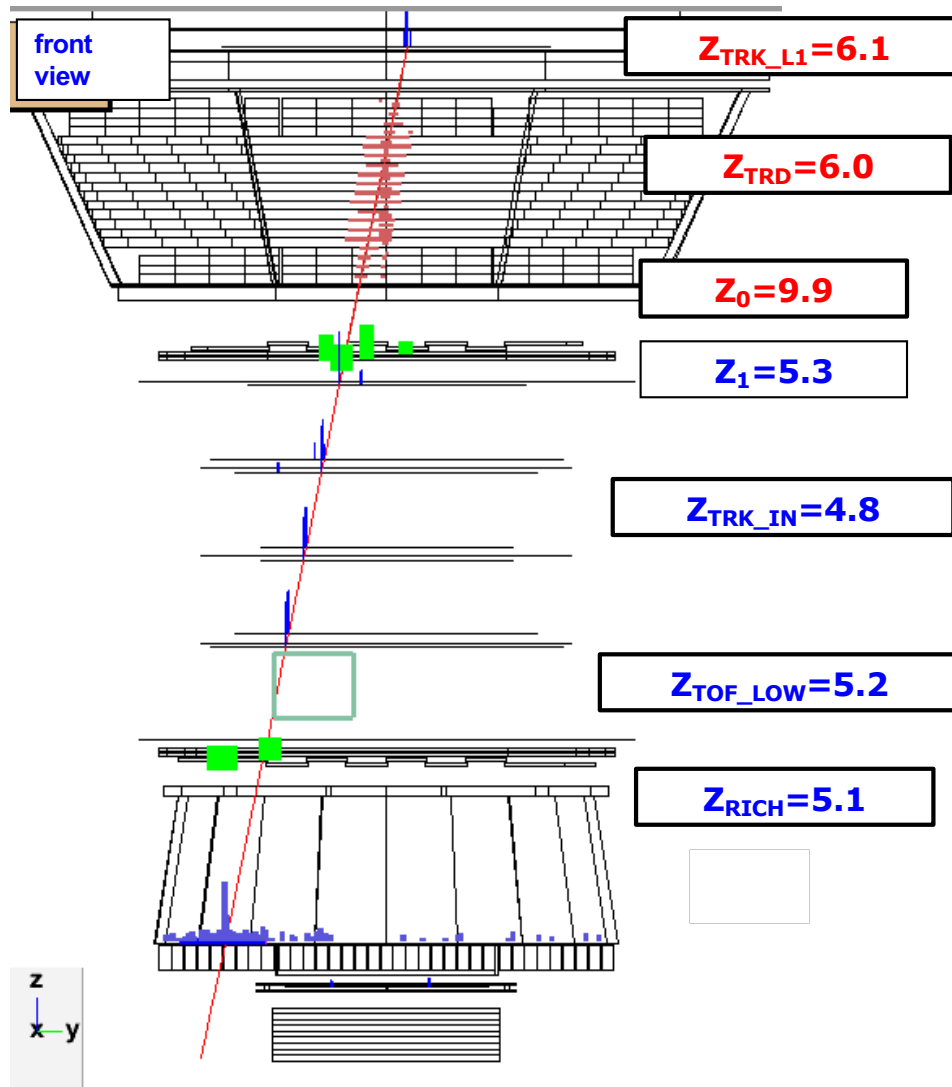

Selecting, for example, a Boron sample, with the full apparatus (i.e. the "inner tracker") is not enough to guarantee a genuine Boron sample...

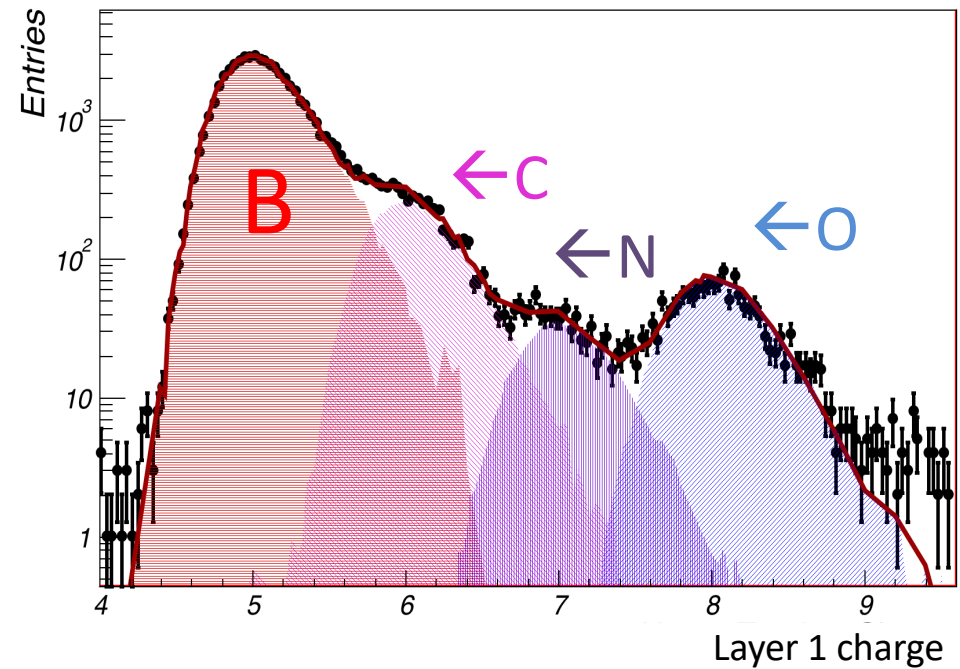

You keep systematics well under control if you:

- control the fragmentation inside the detector
- measure the charge "as TOI as possible"

# AMS-02 Layer0 upgrade

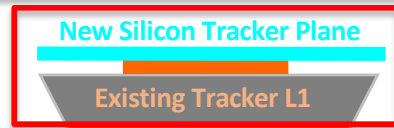

→ add (early 2026) an as large as possible outermost layer to increase lever arm and measure charge before fragmentation

→ "lightest" possible cover, "cupola", to avoid fragmentation

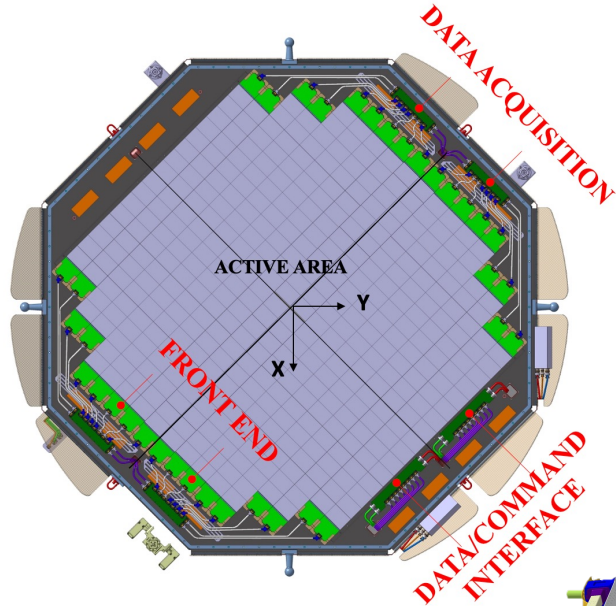
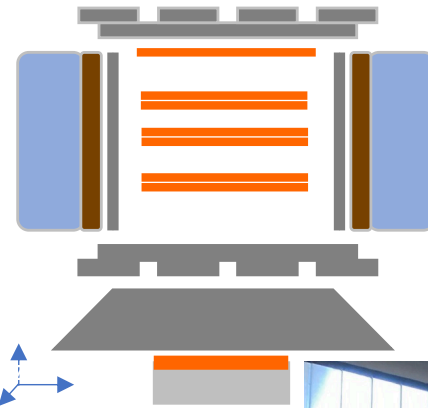

~ 8 m<sup>2</sup> surface  
 2 layers (45° stereo)  
 768 sensors  
 72 ladders  
 72k channels  
 ~ 120 W

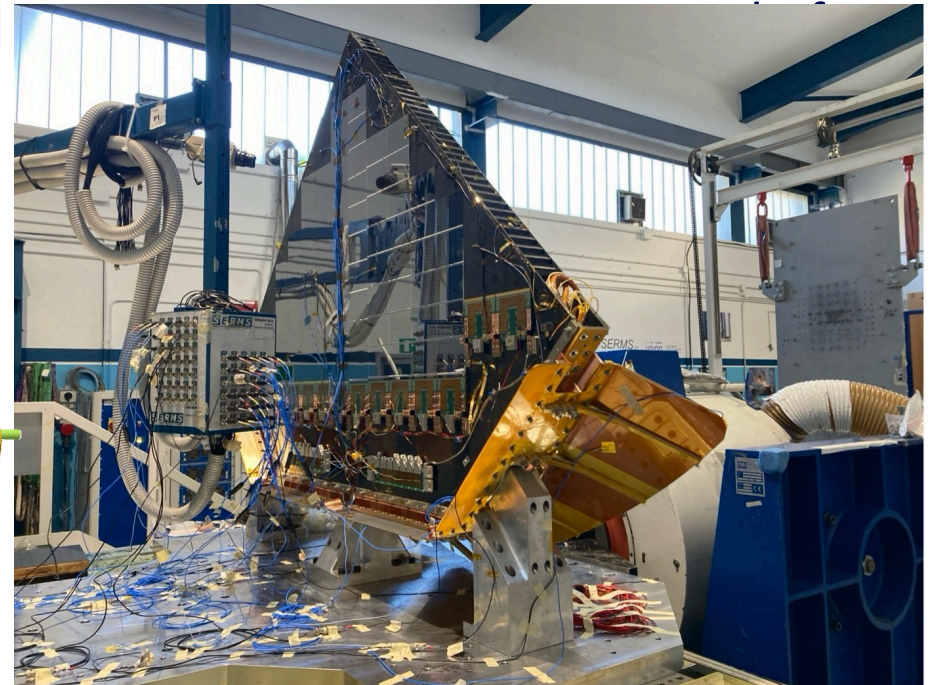
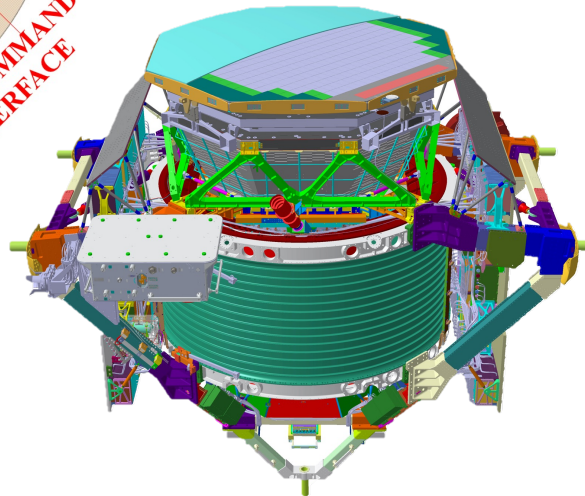

# Key concepts/detectors

## $\beta$ measurement:

- identify the different isotopes (d/p,  $^3\text{He}/^4\text{He}$ ,  $^7\text{Li}/^6\text{Li}$ ,  $^{10}\text{Be}/^9\text{Be}$ ,  $^{27}\text{Al}/^{26}\text{Al}$ , ...)
- control the quality of the momentum/energy measurement (e.g. check on the mass)

## Techniques:

- Time of Flight (ToF)
- Cherenkov (ring or threshold)
- Transition Radiation (measuring  $\gamma$ )

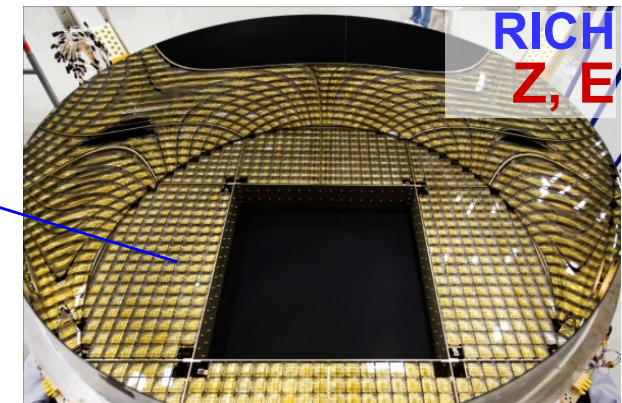
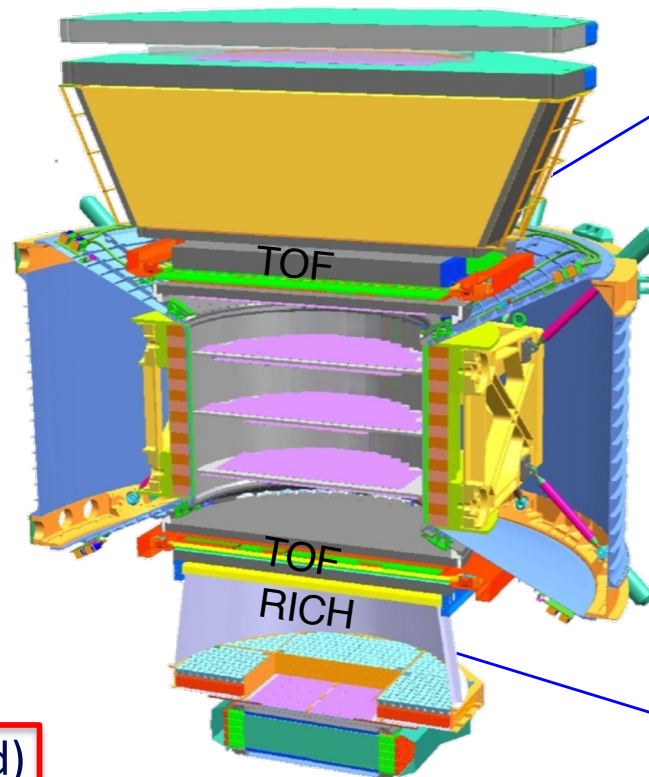



# Key concepts/detectors

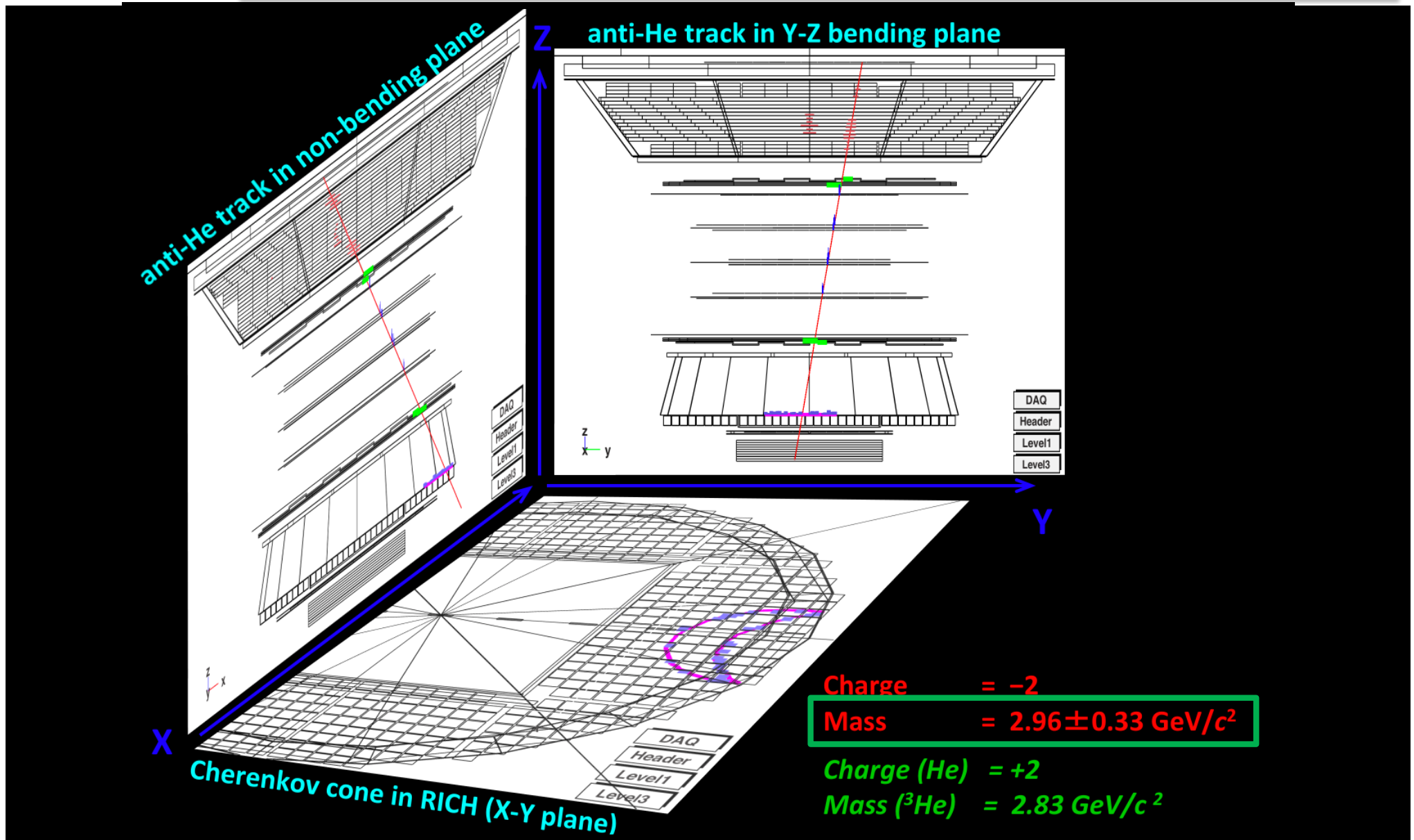

# Key concepts/detectors

## Charge sign measurement:

- matter/anti-matter

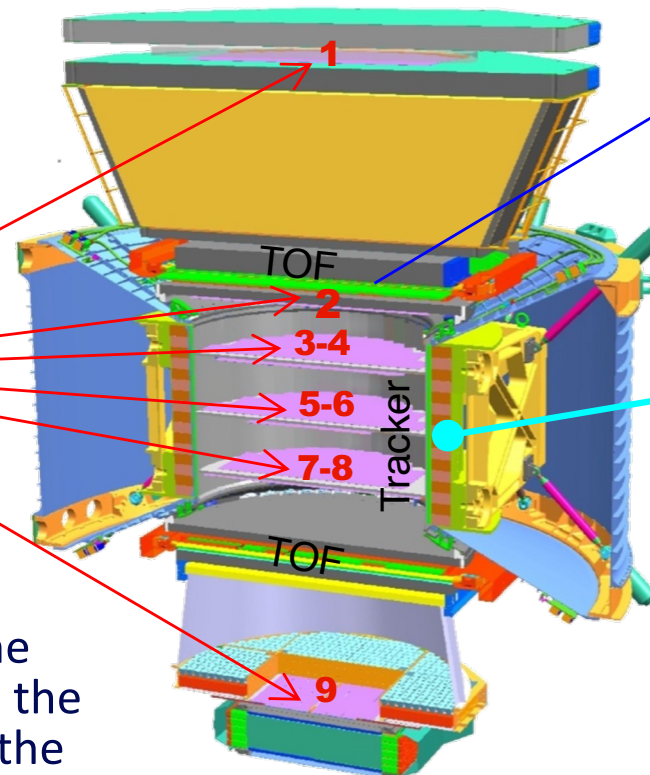
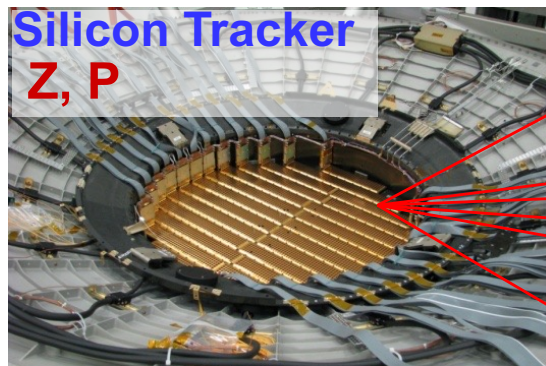
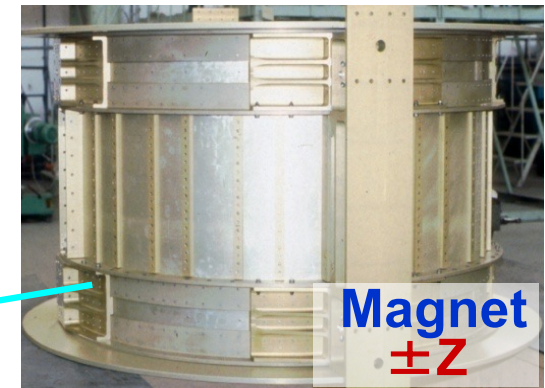

The intensity of the magnetic field (B), the lever arm (L) and the spatial resolution ( $\sigma_x$ ) determine the momentum resolution ( $\delta p$ ) and the detector Maximum Detectable Rigidity, MDR ( $\delta p/p=1$ ):

$$\text{MDR} \propto B L^2 / \sigma_x$$

## Techniques:

- Spectrometry + ToF

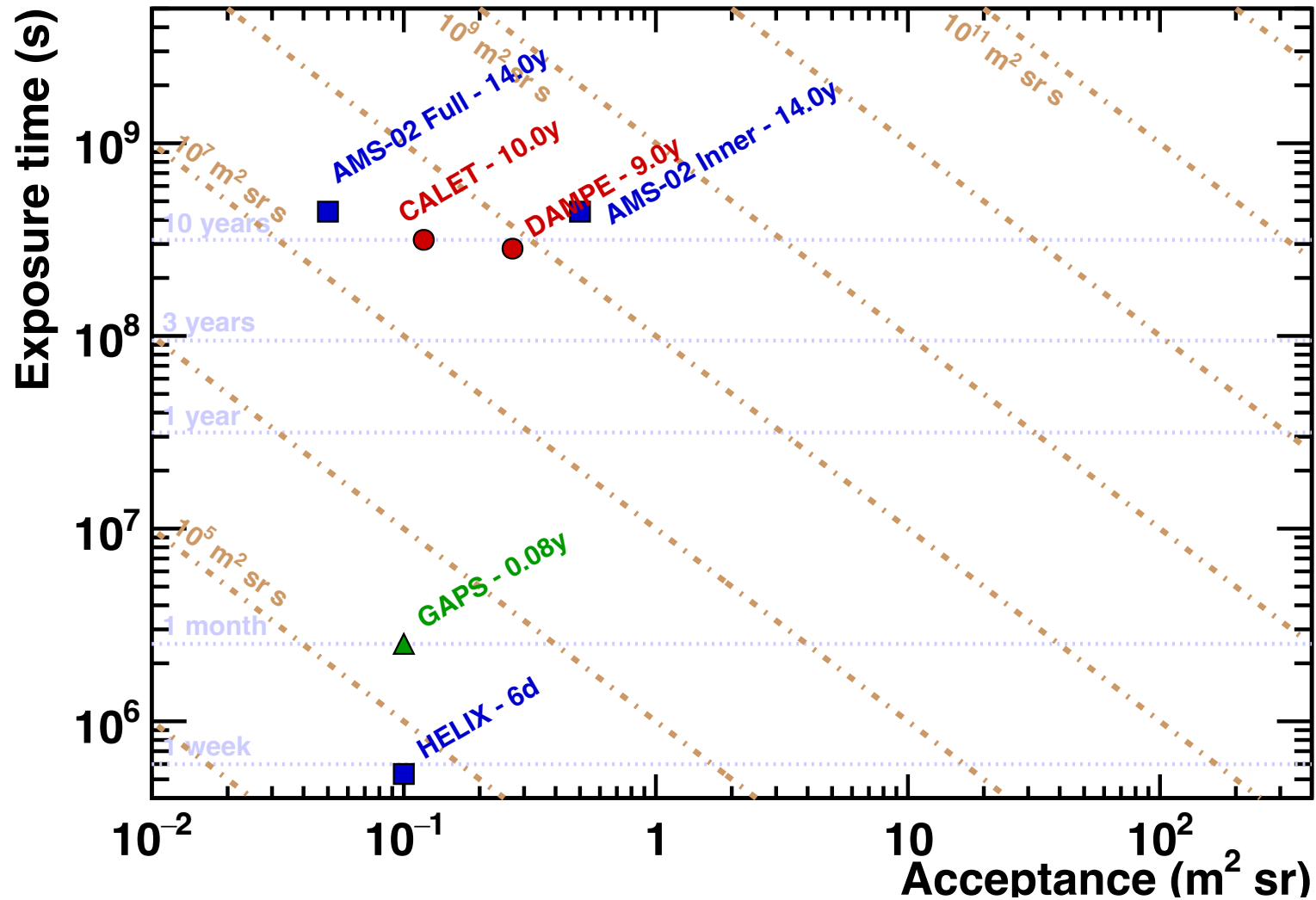

\* focusing on direct "high energy", so not mentioning detectors like CSES-01 & CSES-02 or NUSES...

## Future/proposed $4\pi$ experiments

- HERD
- ALADInO
- AMS-100
- balloon?

# Current operating "telescopes"

DAMPE Field of View ~ 1 sr  
 → Acc ~ 0.3 m<sup>2</sup> sr

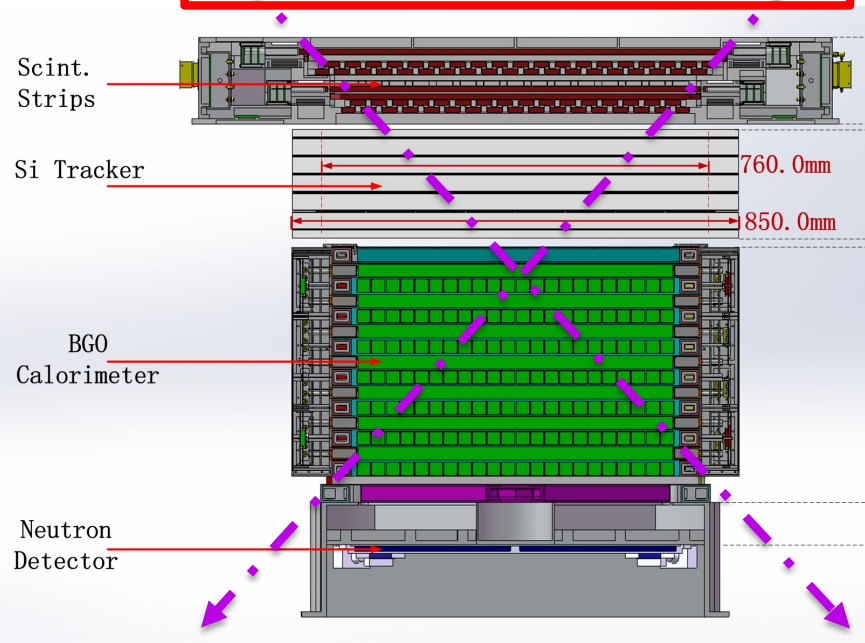

All the current and past detectors are designed as 'telescopes': they're sensitive only to particles impinging from "the top"  
 limited FoV → small acceptance

AMS Inner ~ 0.5 m<sup>2</sup> sr  
 AMS Full Span ~ 0.05 m<sup>2</sup> sr

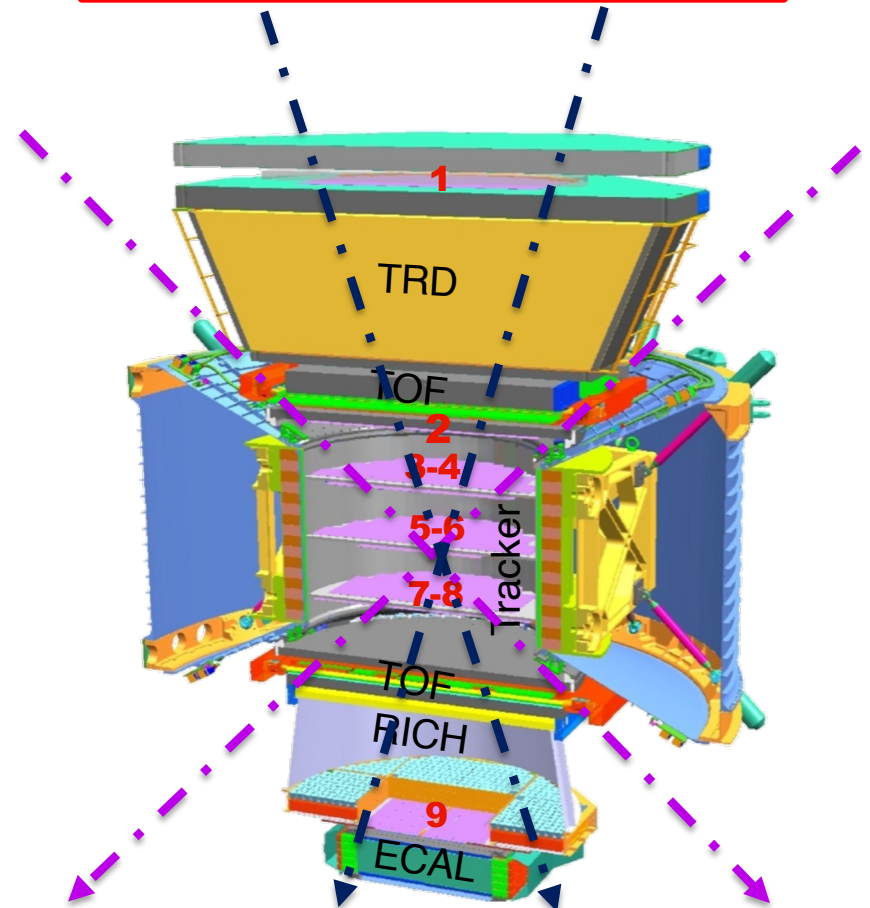

- Exploit the CR "isotropy" to maximize the effective geometrical factor, by using all the surface of the detector (aiming to reach  $\Omega = 4\pi$ )
- The calorimeter should be highly isotropic and homogeneous:
  - the needed depth of the calorimeter must be guaranteed for all the sides (i.e. cube, sphere, ...)
  - the segmentation of the calorimeter should be isotropic

→ this is in general doable just with an homogeneous calorimeter

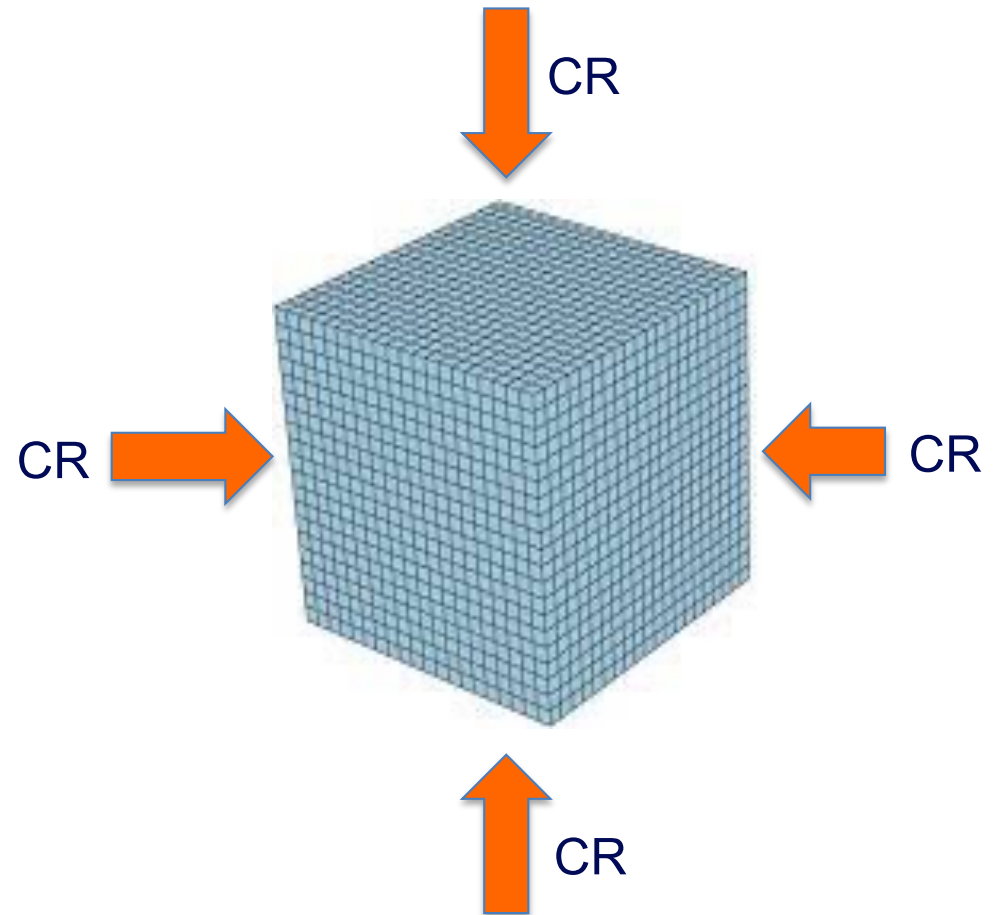

CaloCube is an INFN R&D initiated in Florence (Adriani et al.), almost always inspiring the next generation of large space cosmic rays detectors

# HERD on the CSS

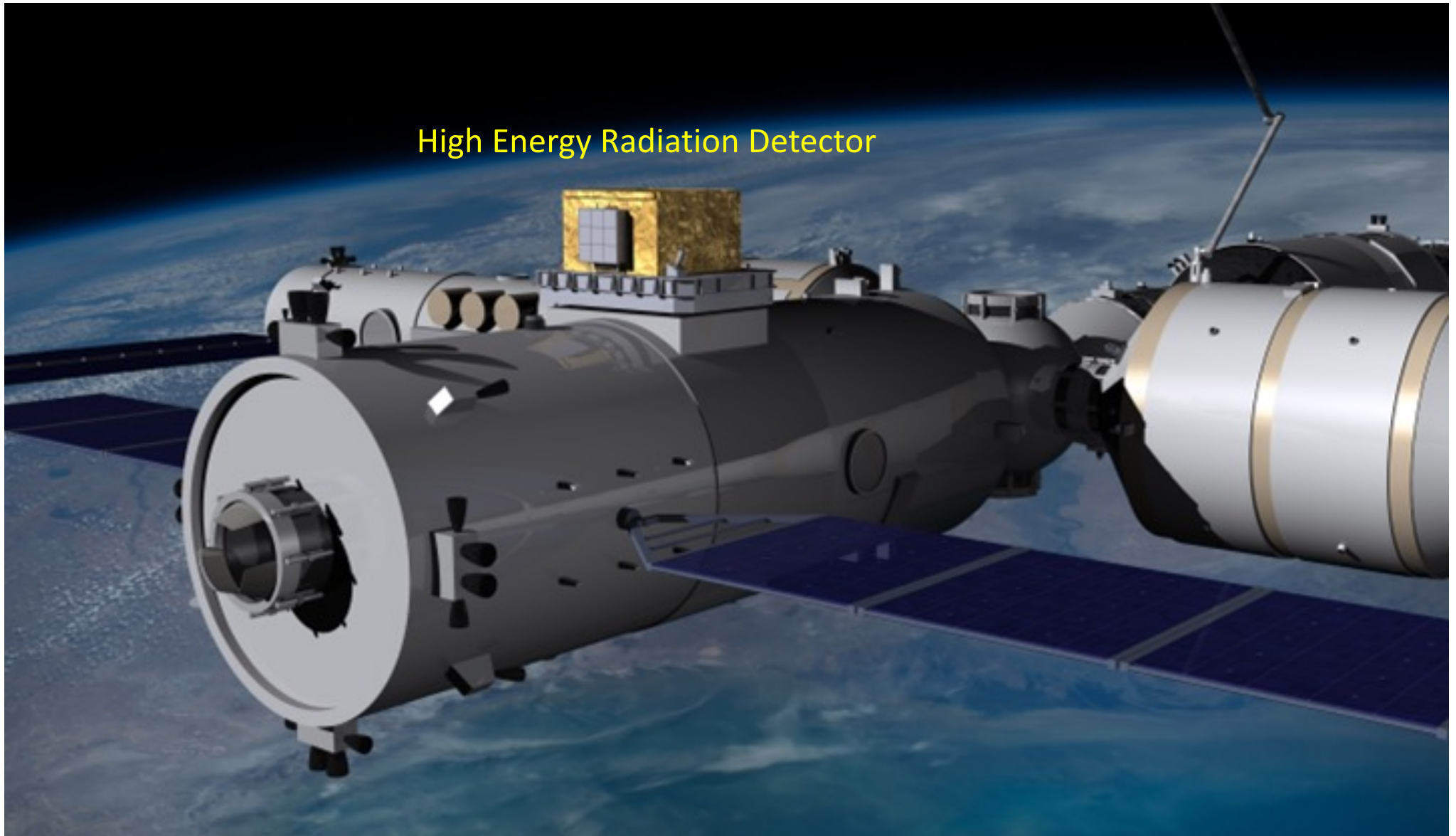

# HERD detector

~ 300k readout channels

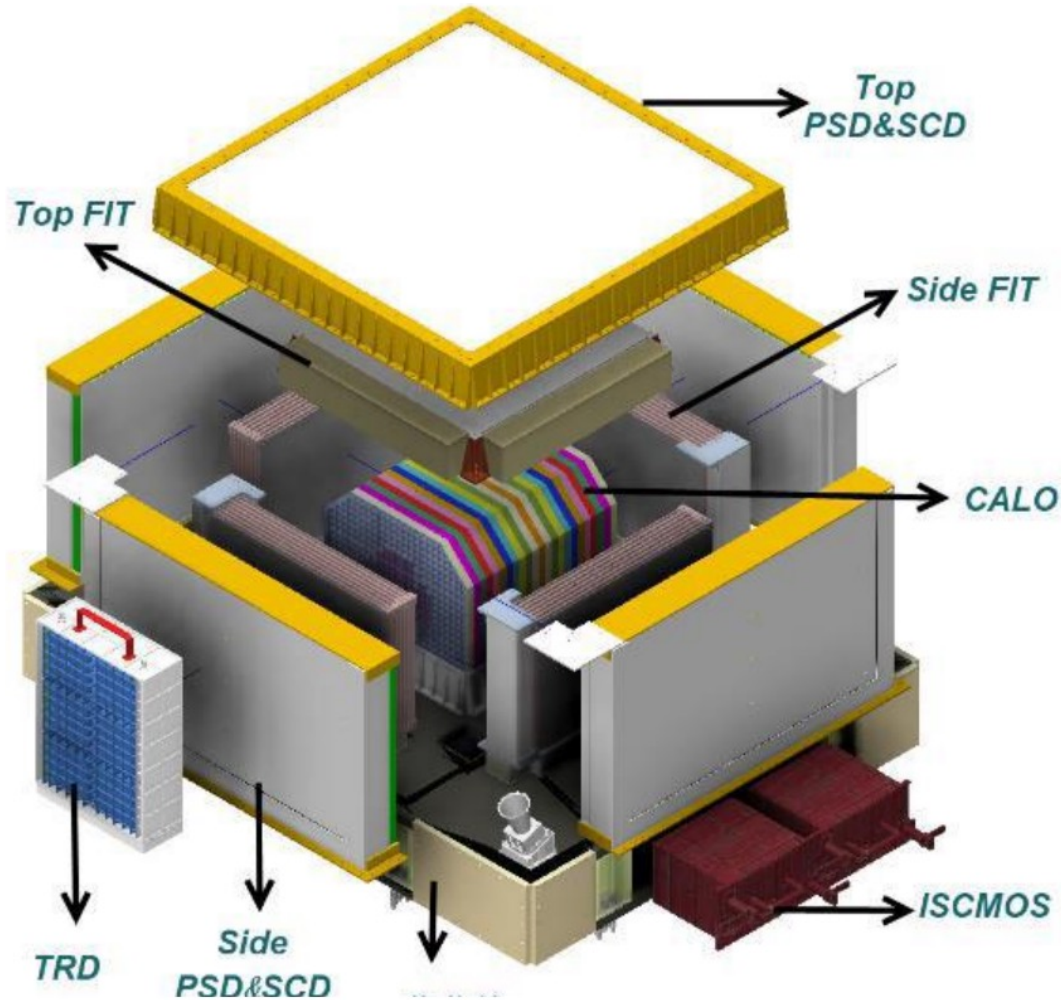

Item	Value
Energy range (e/ $\gamma$ )	10 GeV - 100 TeV (e); 0.5 GeV - 100 TeV ( $\gamma$ )
Energy range (nuclei)	30 GeV - 3 PeV
Angle resolution	0.1 deg.@10 GeV
Charge resolution	0.1-0.15 c.u
Energy resolution (e)	1-1.5%@200 GeV
Energy resolution (p)	20-30%@100 GeV - PeV
e/p separation	$\sim 10^{-6}$
G.F. (e)	$>3 \text{ m}^2\text{sr}@200 \text{ GeV}$
G.F. (p)	$>2 \text{ m}^2\text{sr}@100 \text{ TeV}$
Field of View	$\sim 6 \text{ sr}$
Envelope (L*W*H)	$\sim 2300*2300*2000 \text{ mm}^3$
Weight	$\sim 4000 \text{ kg}$
Power Consumption	$\sim 1400 \text{ W}$

operative from 2027 on the CSS



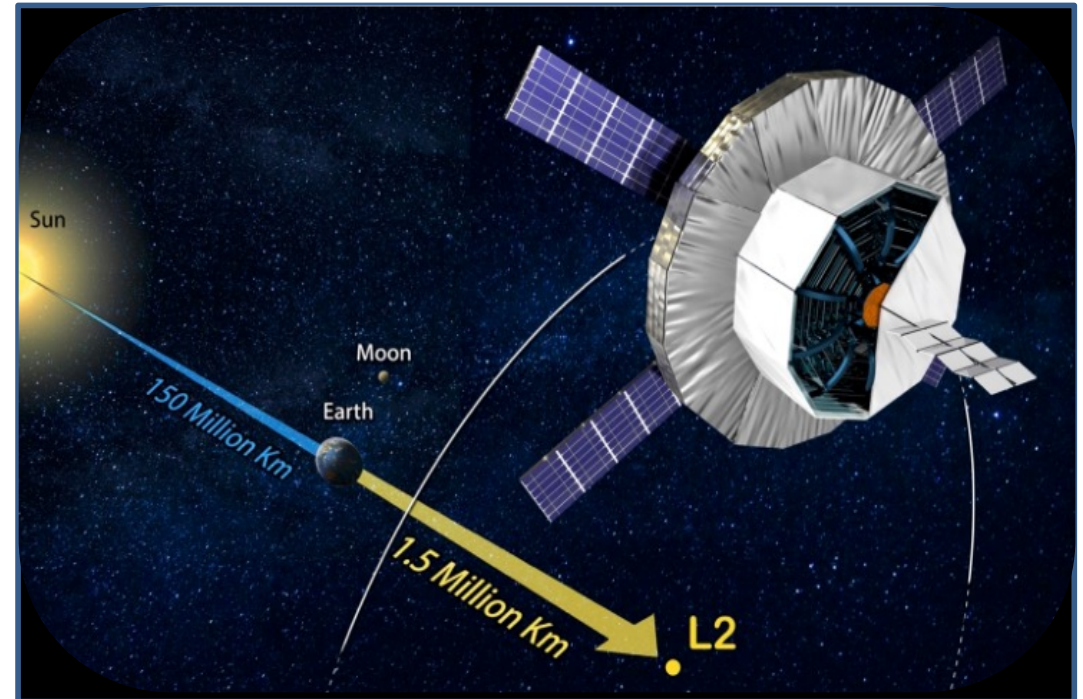
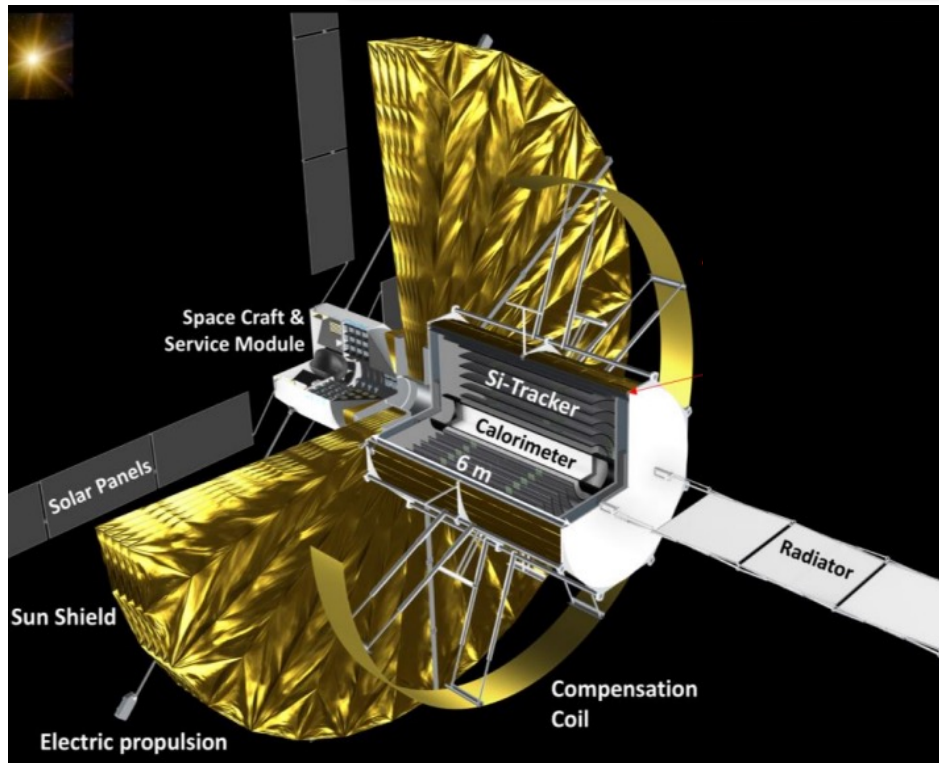

AMS-100: The next generation magnetic spectrometer in space – An international science platform for physics and astrophysics at Lagrange point 2

S. Schael<sup>a</sup>, A. Atanasyan<sup>b</sup>, J. Berdugo<sup>c</sup>, T. Bretz<sup>d</sup>, M. Czupalla<sup>e</sup>, B. Dachwald<sup>e</sup>, P. von Doetinchem<sup>f</sup>, M. Duranti<sup>g</sup>, H. Gast<sup>a</sup>, W. Karpinski<sup>a</sup>, T. Kirn<sup>a</sup>, K. Lübelmeyer<sup>a</sup>, C. Maña<sup>c</sup>, P.S. Marrocchesi<sup>h</sup>, P. Mertsch<sup>i</sup>, I.V. Moskalenko<sup>j</sup>, T. Schervan<sup>k</sup>, M. Schluse<sup>b</sup> ... J. Zimmermann<sup>k</sup>

<https://doi.org/10.1016/j.nima.2019.162561>

Open Access Feature Paper Article

## Design of an Antimatter Large Acceptance Detector In Orbit (ALADInO)

by Oscar Adriani<sup>1,2</sup>, Corrado Altomare<sup>3</sup>, Giovanni Ambrosi<sup>4</sup>, Philipp Azzarello<sup>5</sup>, Felicia Carla Tiziana Barbato<sup>6,7</sup>, Roberto Battiston<sup>8,9</sup>, Bertrand Baudouy<sup>10</sup>, Benedikt Bergmann<sup>11</sup>, Eugenio Berti<sup>1,2</sup>, Bruna Bertucci<sup>12,4</sup>, Mirko Boezio<sup>13,14</sup>, Valter Bonvicini<sup>13</sup>, Sergio Bottai<sup>2</sup>, Petr Burian<sup>11</sup>, Mario Buscemi<sup>15,16</sup>, Franck Cadoux<sup>5</sup>, Valerio Calvelli<sup>17,†</sup>, Donatella Campana<sup>18</sup>, Jorge Casaus<sup>19</sup>, Andrea Contin<sup>20,21</sup> ... Show full author list

<https://doi.org/10.3390/instruments6020019>

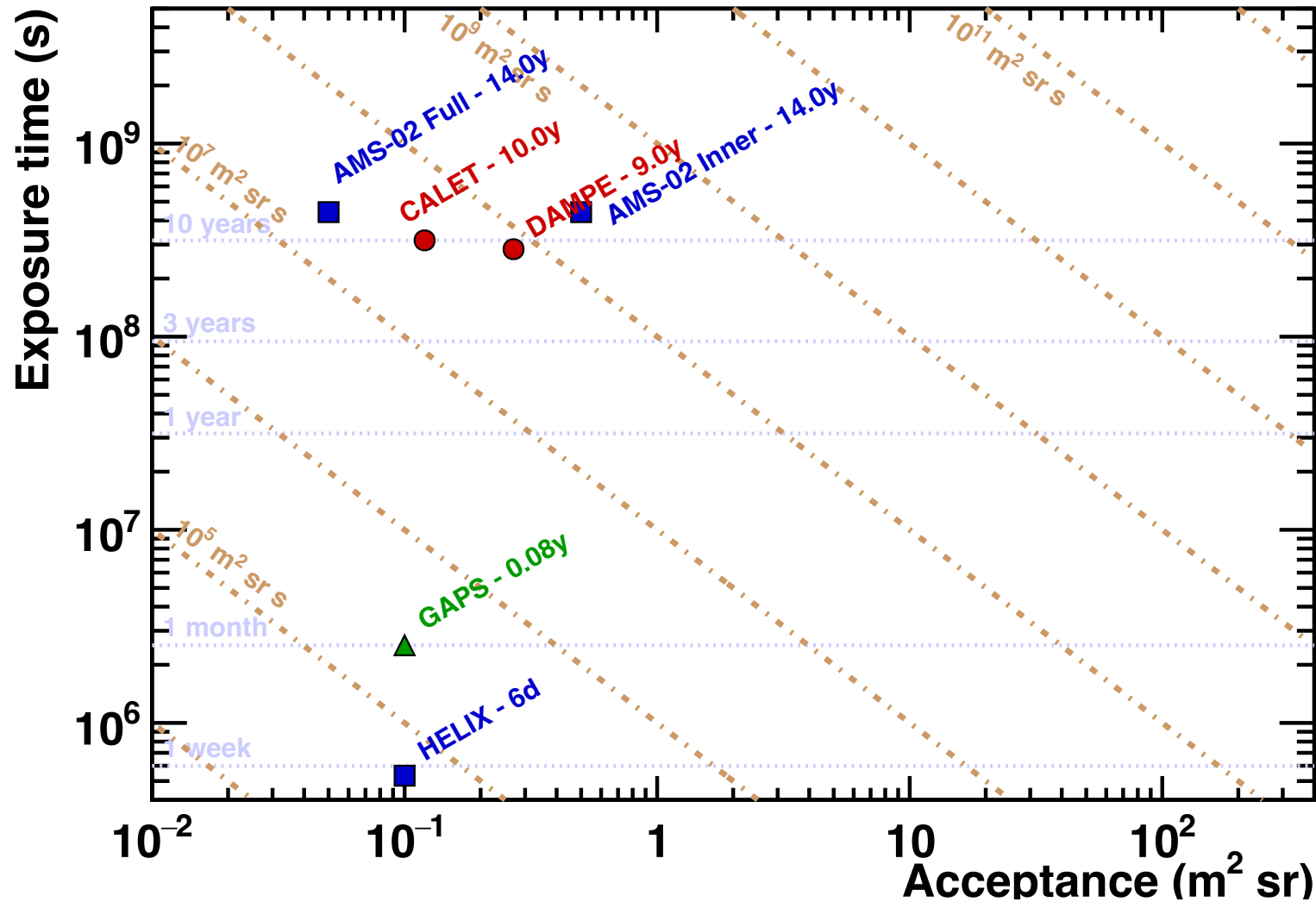

\* focusing on direct "high energy", so not mentioning detectors like CSES-01 & CSES-02 or NUSES...

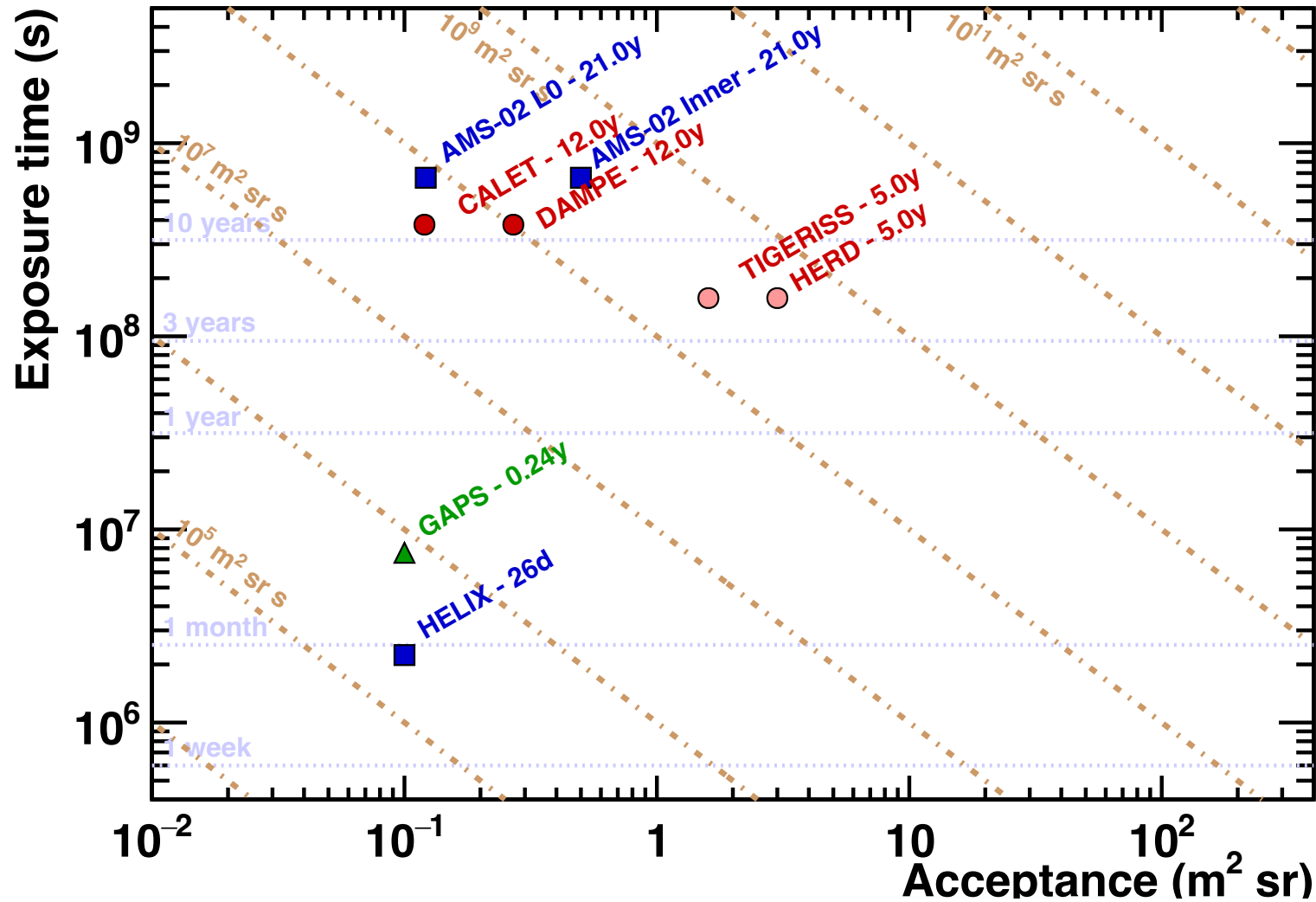

\* focusing on direct "high energy", so not mentioning detectors like CSES-01 & CSES-02 or NUSES...

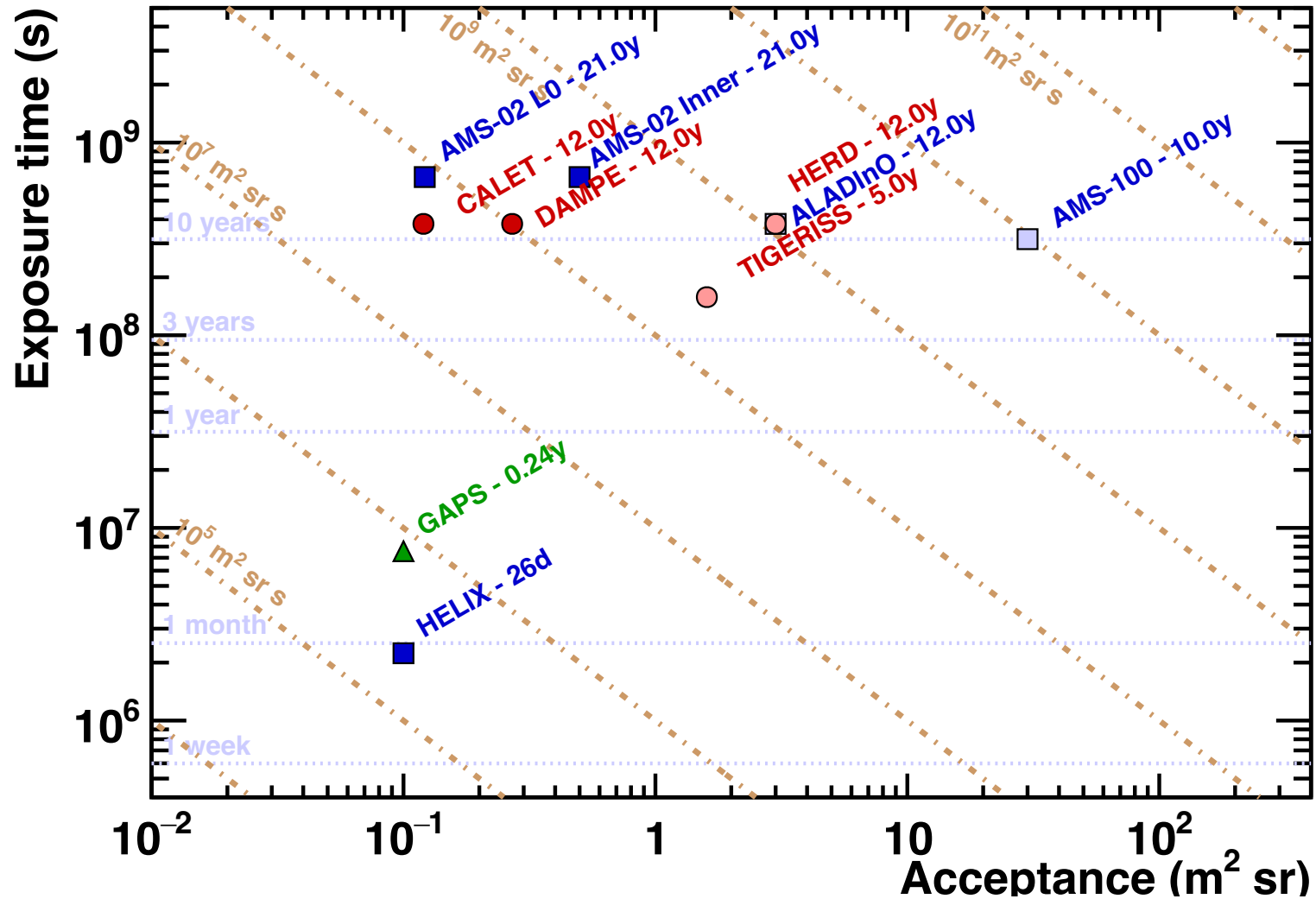

\* focusing on direct "high energy", so not mentioning detectors like CSES-01 & CSES-02 or NUSES...

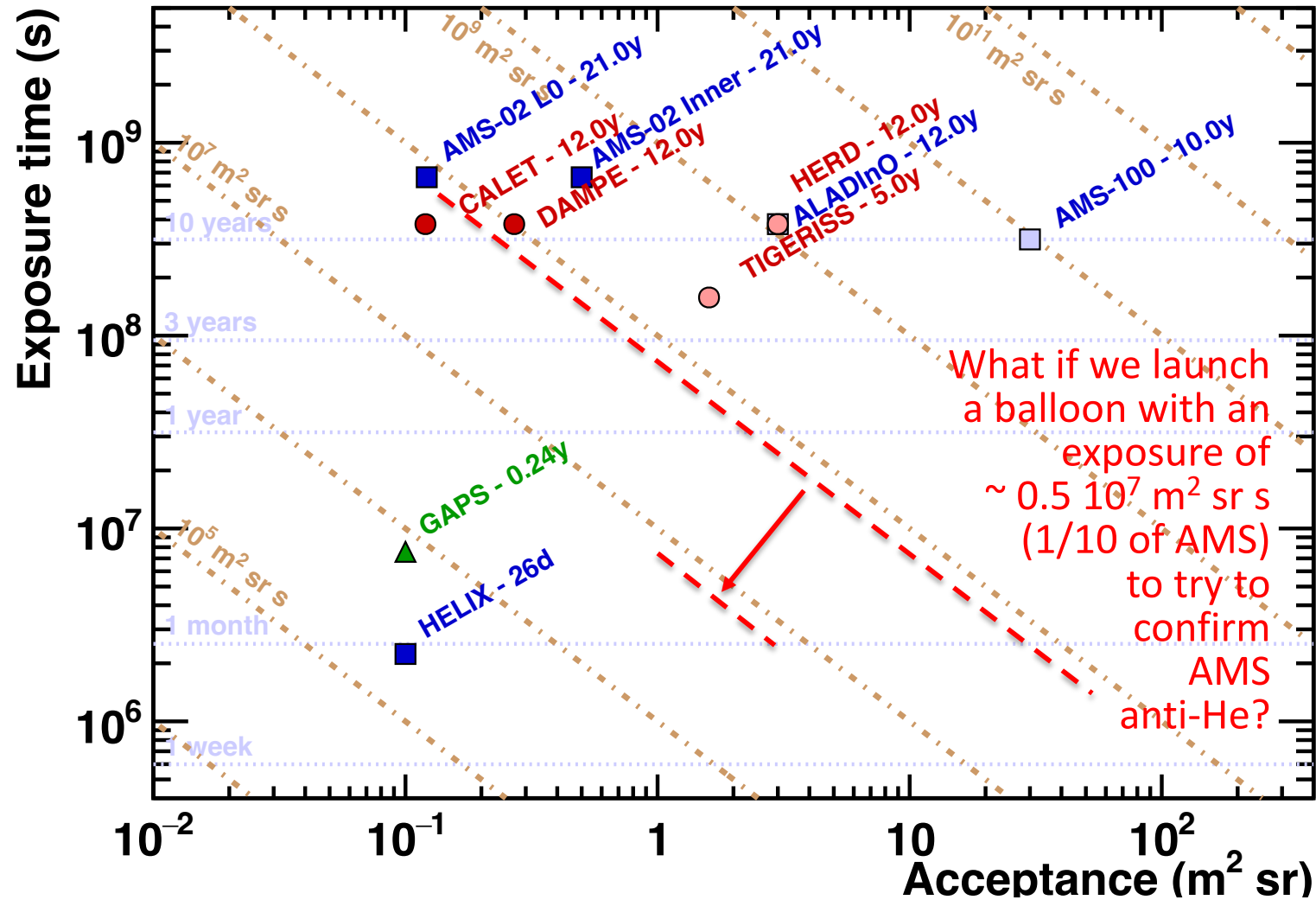

\* focusing on direct "high energy", so not mentioning detectors like CSES-01 & CSES-02 or NUSES...

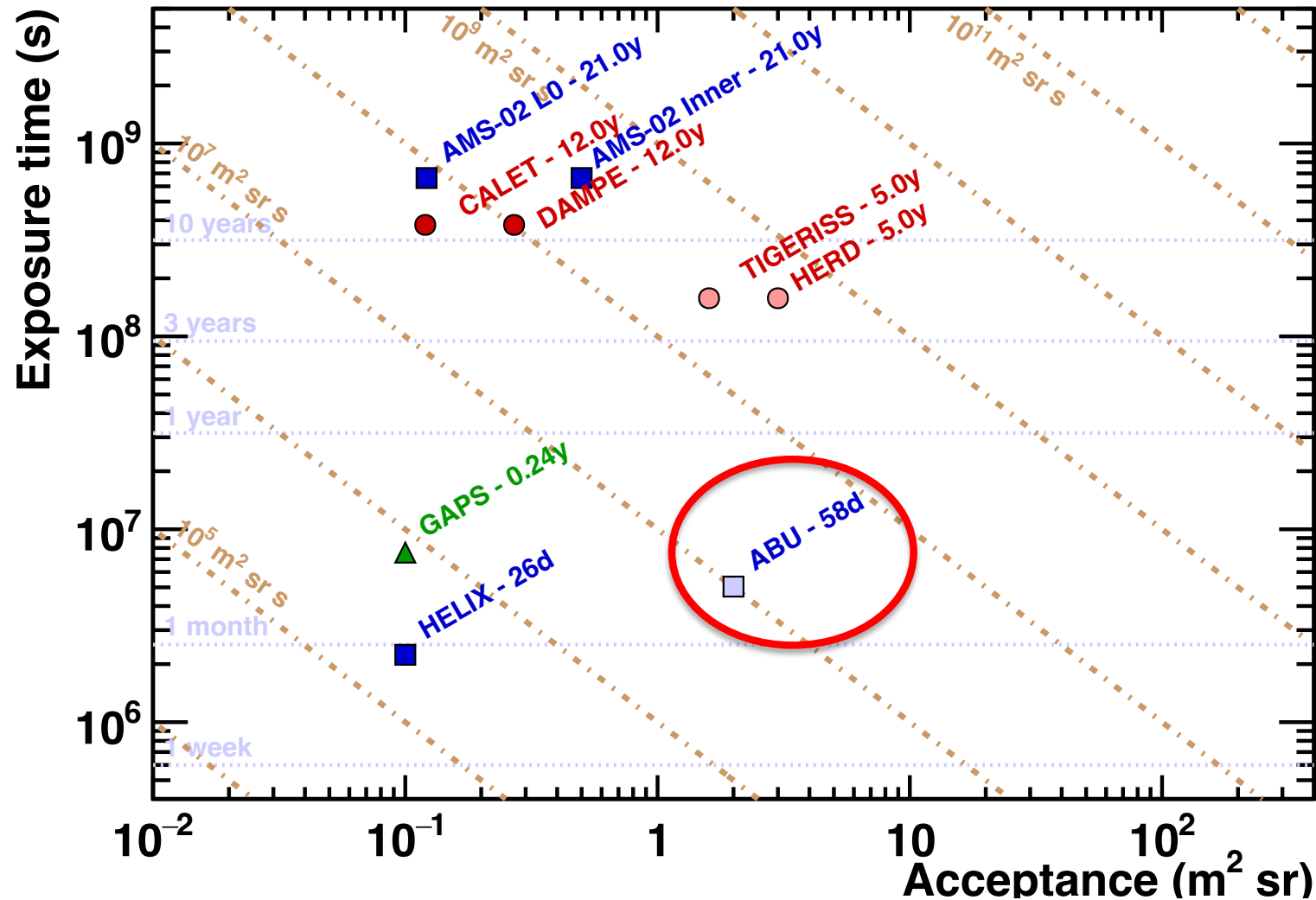

\* focusing on direct "high energy", so not mentioning detectors like CSES-01 & CSES-02 or NUSES...

# What we need?

- measure energy/momentum:

- calorimetry
- HTS magnetic spectrometry + high resolution tracking system (MAPS?)

Trento/Milano groups:  
[Supercond. Sci. Technol. 36 \(2023\) 014007](#)  
 Aachen/Geneva groups:  
[Volume 1040, 1 October 2022, 167215](#)

Trento/Torino groups:  
[Volume 1063, June 2024, 169281](#)

- measure sign of charge:

- magnetic spectrometry + time of flight
- topology of annihilation (tracking/calorimetry)

- measure charge:

- dE/dx (tracking/scintillation)
- number of photons in Cherenkov radiation

- measure mass ( $\beta/\gamma + E/p$ ):

- time of flight (20 ps: plastic scintillator + SiPMs? LGAD tracker?)
- Cherenkov (DIRC?)
- transition radiation

Perugia/Roma/Bologna groups:  
[Instruments 2021, 5\(2\), 20](#)

Aachen/PSI groups:  
[Instruments 2022, 6\(1\), 14](#)

- transition radiation
- shower development (calorimetry)
- energy/momentum match
- neutron produced in hadronic shower (neutron detector)
- calorimeter back-scattering timing measurement ?

Darmstadt/Frankfurt/Mainz groups:  
[NIMA, Volume 952, 1 February 2020, 161790](#)

Stay tuned...

